

SUPER[®]●

SUPER[®]● X7DBi+

USER'S MANUAL

Revision 1.1

The information in this User's Manual has been carefully reviewed and is believed to be accurate. The vendor assumes no responsibility for any inaccuracies that may be contained in this document, makes no commitment to update or to keep current the information in this manual, or to notify any person or organization of the updates. **Please Note: For the most up-to-date version of this manual, please see our web site at www.supermicro.com.**

Super Micro Computer, Inc. ("Supermicro") reserves the right to make changes to the product described in this manual at any time and without notice. This product, including software, if any, and documentation may not, in whole or in part, be copied, photocopied, reproduced, translated or reduced to any medium or machine without prior written consent.

IN NO EVENT WILL SUPERMICRO BE LIABLE FOR DIRECT, INDIRECT, SPECIAL, INCIDENTAL, SPECULATIVE OR CONSEQUENTIAL DAMAGES ARISING FROM THE USE OR INABILITY TO USE THIS PRODUCT OR DOCUMENTATION, EVEN IF ADVISED OF THE POSSIBILITY OF SUCH DAMAGES. IN PARTICULAR, SUPERMICRO SHALL NOT HAVE LIABILITY FOR ANY HARDWARE, SOFTWARE, OR DATA STORED OR USED WITH THE PRODUCT, INCLUDING THE COSTS OF REPAIRING, REPLACING, INTEGRATING, INSTALLING OR RECOVERING SUCH HARDWARE, SOFTWARE, OR DATA.

Any disputes arising between manufacturer and customer shall be governed by the laws of Santa Clara County in the State of California, USA. The State of California, County of Santa Clara shall be the exclusive venue for the resolution of any such disputes. Supermicro's total liability for all claims will not exceed the price paid for the hardware product.

FCC Statement: This equipment has been tested and found to comply with the limits for a Class A digital device pursuant to Part 15 of the FCC Rules. These limits are designed to provide reasonable protection against harmful interference when the equipment is operated in a commercial environment. This equipment generates, uses, and can radiate radio frequency energy and, if not installed and used in accordance with the manufacturer's instruction manual, may cause harmful interference with radio communications. Operation of this equipment in a residential area is likely to cause harmful interference, in which case you will be required to correct the interference at your own expense.

California Best Management Practices Regulations for Perchlorate Materials: This Perchlorate warning applies only to products containing CR (Manganese Dioxide) Lithium coin cells. "Perchlorate Material-special handling may apply. See www.dtsc.ca.gov/hazardouswaste/perchlorate"

WARNING: Handling of lead solder materials used in this product may expose you to lead, a chemical known to the State of California to cause birth defects and other reproductive harm.

Manual Revision 1.1
Release Date: June 25, 2009

Unless you request and receive written permission from Super Micro Computer, Inc., you may not copy any part of this document.

Information in this document is subject to change without notice. Other products and companies referred to herein are trademarks or registered trademarks of their respective companies or mark holders.

Copyright © 2009 by Super Micro Computer, Inc.
All rights reserved.
Printed in the United States of America

Preface

About This Manual

This manual is written for system integrators, PC technicians and knowledgeable PC users. It provides information for the installation and use of the **SUPER** X7DBi+ motherboard. The **SUPER** X7DBi+ supports dual Intel Quad-Core and Dual-Core Xeon 5300/5100/5000 Series processors with a front side bus speed of 1.333 GHz/1.066 GHz/667 MHz. With two 64-bit Quad-Core/Dual-Core processors installed, the X7DBi+ offers superior performance, system reliability and power efficiency for storage platforms. The features supported by this motherboard include the Intel Core Microarchitecture, ultra dense low-power platform, larger cache with 4 MB shared L2 capacity, the Intel Virtualization Technology, the Intel Extended Memory 64 Technology (EM64), and the Intel I/O Acceleration Technology (Intel I/OAT). The X7DBi+ offers a superb solution for intense computing and complex I/O performance, especially ideal for high-end server platforms. Please refer to our web site (<http://www.supermicro.com/products/motherboard/>) for updates on supported processors. This product is intended to be professionally installed.

Manual Organization

Chapter 1 describes the features, specifications and performance of the main board and provides detailed information about the chipset.

Chapter 2 provides hardware installation instructions. Read this chapter when installing the processor, memory modules and other hardware components into the system. If you encounter any problems, see **Chapter 3**, which describes troubleshooting procedures for video, memory and system setup stored in the CMOS.

Chapter 4 includes an introduction to BIOS and provides detailed information on running the CMOS Setup utility.

Appendix A provides BIOS Beep Codes. **Appendix B** and **Appendix C** list the Windows OS and other software installation instructions.

Conventions Used in the Manual:

Special attention should be given to the following symbols for proper installation and to prevent damage done to the components or injury to yourself:



Danger/Caution: Instructions to be strictly followed to prevent catastrophic system failure or to avoid bodily injury.



Warning: Important information given to ensure proper system installation or to prevent damage to the components.

Note: Additional Information given to differentiate various models or to ensure correct system setup.

Table of Contents

Preface

About This Manual	iii
Manual Organization	iii
Conventions Used in the Manual.....	iii

Chapter 1: Introduction

1-1 Overview	1-1
Checklist	1-1
Contacting Supermicro	1-2
SUPER [®] X7DBi+ Image	1-3
SUPER [®] X7DBi+ Layout	1-4
Quick Reference	1-5
Motherboard Features.....	1-6
Intel Blackford Chipset: System Block Diagram	1-8
1-2 Chipset Overview	1-9
1-3 Special Features	1-10
Recovery from AC Power Loss	1-10
1-4 PC Health Monitoring	1-10
1-5 ACPI Features	1-11
1-6 Power Supply	1-12
1-7 Super I/O	1-12

Chapter 2: Installation

2-1 Static-Sensitive Devices	2-1
Precautions.....	2-1
Unpacking	2-1
2-2 Processor and Heatsink Installation	2-2
2-3 Installing DIMMs	2-6
2-4 Control Panel Connectors and IO Ports	2-8
A. Back Panel Connectors/IO Ports.....	2-8
B. Front Control Panel.....	2-9
C. Front Control Panel Pin Definitions.....	2-10
NMI Button	2-10
Power LED	2-10
HDD LED	2-11
NIC1/NIC2 LED	2-11
Overheat/Fan Fail LED	2-12
Power Fail LED.....	2-12
Reset Button	2-13

Power Button	2-13
2-5 Connecting Cables	2-14
ATX Power Connector	2-14
Processor Power Connector	2-14
Universal Serial Bus	2-15
Chassis Intrusion	2-15
Fan Headers	2-16
Keylock	2-16
ATX PS/2 Keyboard and Mouse Ports	2-17
Serial Ports	2-17
Wake-On-Ring	2-18
Wake-On-LAN	2-18
GLAN (Ethernet Ports)	2-19
Speaker/Power LED/Keylock Header	2-19
Power Fault	2-20
Alarm Reset	2-20
SMB Connector	2-21
SMB Power Connector	2-21
T-SGPIO Headers	2-21
VGA Connector	2-22
Compact Flash Card PWR Connector	2-23
2-6 Jumper Settings	2-24
Explanation of Jumpers	2-24
GLAN Enable/Disable	2-24
Clear CMOS	2-25
Watch Dog	2-25
3rd PWR Supply PWR Fault	2-26
VGA Enable/Disable	2-26
Compact Flash Master/Slave Enable/Disable	2-27
I ² C Bus to PCI-X/PCI-Exp. Slots Enable/Disable	2-27
2-7 Onboard Indicators	2-28
GLAN LEDs	2-28
Onboard Standby PWR LED	2-28
Overheat/Fan Fail LED	2-29
2-8 Parallel Port, Floppy, Hard Disk Drive and SIMLP Connections	2-30
Parallel Port Connector	2-30
Floppy Connector	2-31
SIMLP Slot	2-31
IDE Connectors	2-32

Chapter 3: Troubleshooting

3-1	Troubleshooting Procedures	3-1
	Before Power On.....	3-1
	No Power.....	3-1
	No Video	3-1
	Losing the System's Setup Configuration	3-1
	Memory Errors.....	3-2
3-2	Technical Support Procedures	3-2
3-3	Frequently Asked Questions	3-3
3-4	Returning Merchandise for Service	3-4

Chapter 4: BIOS

4-1	Introduction	4-1
4-2	Running Setup	4-2
4-3	Main BIOS Setup	4-2
4-4	Advanced Setup	4-6
4-5	Security Setup	4-25
4-6	Boot Setup	4-26
4-7	Exit	4-27

Appendices:

Appendix A: BIOS Beep Codes	A-1
Appendix B: Installing the Windows OS	B-1
Appendix C: Installing Other Software Programs	C-1

Chapter 1

Introduction

1-1 Overview

Checklist

Congratulations on purchasing your computer motherboard from an acknowledged leader in the industry. Supermicro boards are designed with the utmost attention to detail to provide you with the highest standards in quality and performance. Check that the following items have all been included with your motherboard. If anything listed here is damaged or missing, contact your retailer.

All the following items are included in the retail box.

One (1) Supermicro Mainboard

One (1) ribbon cable for IDE devices (CBL-0036L-03)

One (1) Serial Port cable (CBL-010L-01)

One (1) USB cable (CBL-0083L)

One (1) floppy ribbon cable (CBL-0022L)

Six (6) SATA cables (CBL-0044L)

One (1) I/O backpanel shield (CSE-PT07L)

One (1) Supermicro CD containing drivers and utilities

One (1) User's/BIOS Manual

Contacting Supermicro

Headquarters

Address: Super Micro Computer, Inc.
980 Rock Ave.
San Jose, CA 95131 U.S.A.

Tel: +1 (408) 503-8000

Fax: +1 (408) 503-8008

Email: marketing@supermicro.com (General Information)
support@supermicro.com (Technical Support)

Web Site: www.supermicro.com

Europe

Address: Super Micro Computer B.V.
Het Sterrenbeeld 28, 5215 ML
's-Hertogenbosch, The Netherlands

Tel: +31 (0) 73-6400390

Fax: +31 (0) 73-6416525

Email: sales@supermicro.nl (General Information)
support@supermicro.nl (Technical Support)
rma@supermicro.nl (Customer Support)

Asia-Pacific

Address: Super Micro Computer, Inc.
4F, No. 232-1 Liancheng Road
Chung-Ho 235, Taipei Hsien, Taiwan, R.O.C.

Tel: +886-(2) 8226-3990

Fax: +886-(2) 8226-3991

Web Site: www.supermicro.com.tw

Technical Support:

Email: support@supermicro.com.tw

Tel: 886-2-8228-1366, ext.132 or 139

SUPER[®] X7DBi+ Image

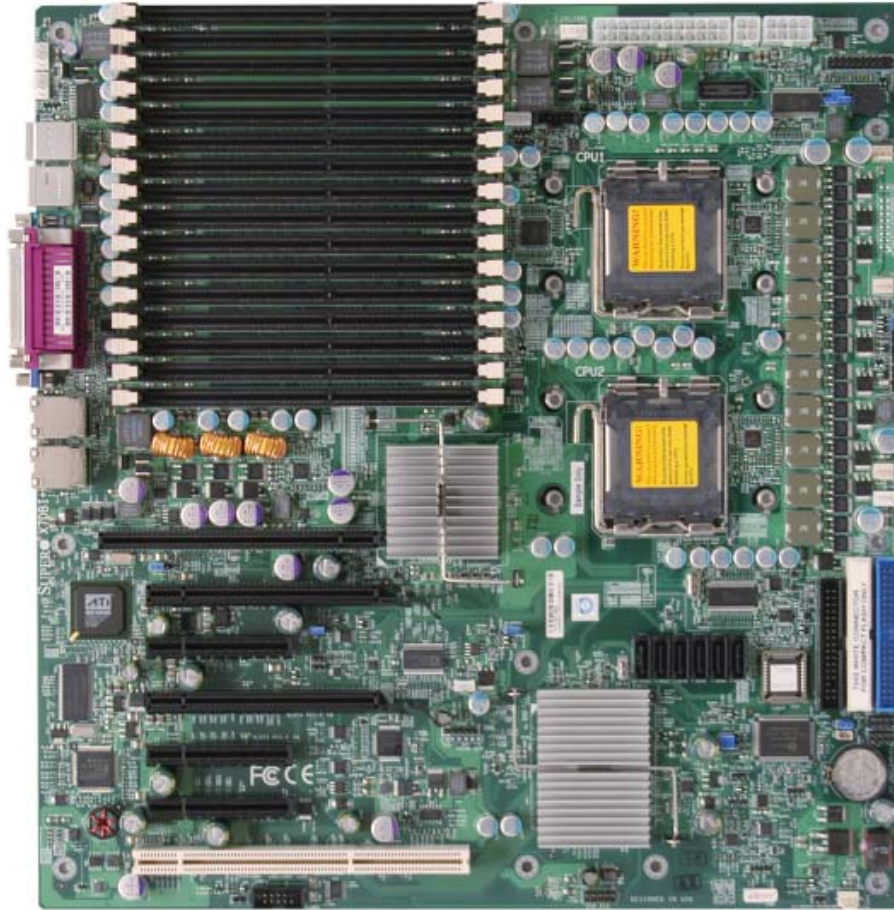

Note: The drawings and pictures shown in this manual were based on the latest PCB Revision available at the time of publishing of the manual. The motherboard you've received may or may not look exactly the same as the graphics shown in the manual.

SUPER X7DBi+ Motherboard Layout

(not drawn to scale)

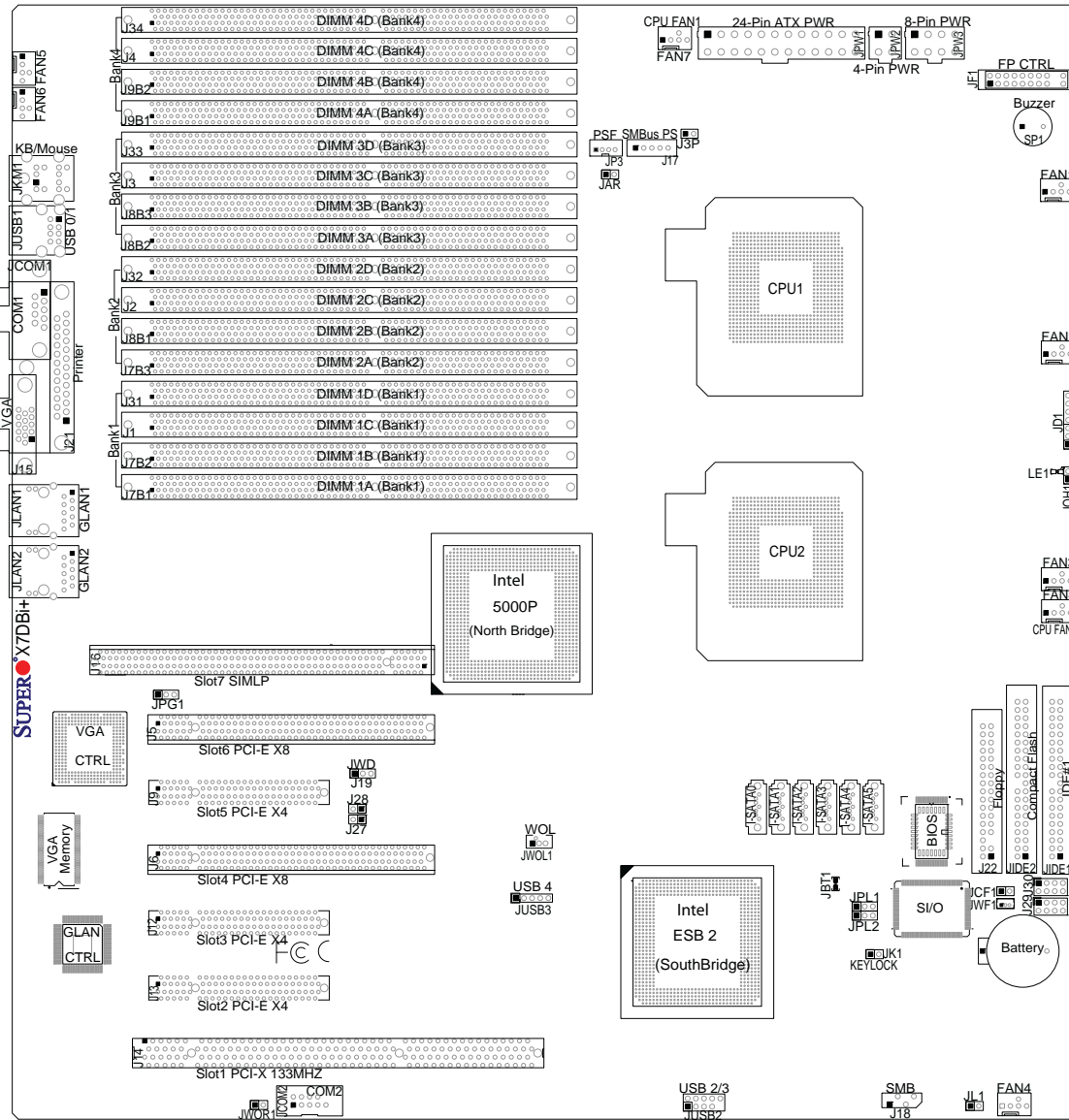

Notes:

1. Jumpers not indicated are for test purposes only.
2. See Chapter 2 for detailed information on jumpers, I/O ports and JF1 front panel connections.
3. "■" indicates the location of Pin 1.
4. When LE1 is on, make sure to unplug the power supply before removing or installing components.

Quick Reference (X7DBi+)

<u>Jumper</u>	<u>Description</u>	<u>Default Setting</u>
J27/J28	I ² C Bus to PCI-X/PCI-E Slots	Open (Disabled)
J3P	3rd PWR Failure Detect	Off (Disabled)
JBT1	CMOS Clear	(See Chapter 2)
JCF1	Compact Card Master/Slave Select	On (Master)
JPG1	VGA Enable	Pins 1-2 (Enabled)
JPL1/JPL2	GLAN1/GLAN2 Enable	Pins 1-2 (Enabled)
JWD (J19)	Watch Dog	Pins 1-2 (Reset)

<u>Connector</u>	<u>Description</u>
ATX PWR (JPW1)	Primary 24-Pin ATX PWR Connector
Aux. PWR/CPU PWR	+12V 4-pin PWR (JWP2)/+12V 8-pin PWR(JPW3)
Alarm Reset (JAR)	Alarm Buzzer Reset
Compact Flash PW(JWF1)	Compact Card PWR Connector(*Used if JFC1 is on.)
COM1/COM2 (JCOM1/2)	COM1/COM2 Serial Port Connectors
Chassis Intru. (JL1)	Chassis Intrusion Header
FAN 1-8	Fans 1-8 (Fan7: CPU Fan1, Fan8: CPU Fan2)
FP CTRL (JF1)	Front Control Panel Connector
Floppy (J22)	Floppy Disk Drive Connector
GLAN 1/2 (JLAN1/2)	G-bit Ethernet Ports
IDE1/IDE2 (Note)	IDE1 Hard Drive (JIDE1)/Compact Flash Card (JIDE2)
KB/Mouse (JKM1)	PS2 Keyboard/Mouse
Keylock (JK1)	Keylock Header
SIMLP (Slot 7)	SIMLP (Supermicro Intelligent Management) Add-On Card Slot Connector
OH LED (JOH1)	Overheat LED
Parallel Port (J21)	Parallel (Printer) Port
PWR LED/Speaker (JD1)	PWR LED(pins1-3)/SpeakerHeader (pins 4-7)
PWR LED (LE1)	PWR LED Indicator (Note6 on Pg.1-4)
PSF (JP3)	Power Fault (Power Supply Failure: See Chapter 2)
SATA0-SATA5	Intel SATA 0-5 Connectors
SMBus PS (J17)	Power System Management (I ² C) Header
SMB (J18)	System Management Bus Header
T-SGPIO 1/2 (J29, J30)	Serial General Purpose Input/Output Headers
USB 0/1 (JUSB1)	Back Panel USB 0/1
USB 2/3,USB4 (JUSB2/3)	Front Panel USB 2/3 (JUSB2), FP USB 4 (JUSB4)
VGA (J15)	VGA Connector
WOL (JWOL1)	Wake-on-LAN Header
WOR (JWOR1)	Wake-on-Ring Header

Note: JIDE2 is for Compact Card Use only. For Compact Card to work properly, please enable JCF1 by putting a jumper on it and connect JWF1 to a power supply.

Motherboard Features

CPU

- Dual Intel® 64-bit LGA 771 Quad-Core/Dual-Core Xeon 5300/5100/5000 Series processors at a front side bus speed of 1.333 GHz/1.066 GHz/667 MHz

Memory

- 16 240-pin DIMM sockets with support up to 64 GB DDR2 FBD (Fully Buffered) ECC 667/533 Memory (*See Section 2-3 in Chapter 2 for DIMM Slot Population.)

Chipset

- Intel 5000P chipset, including: the 5000P Memory Control Hub (MCH) and the Enterprise South Bridge 2 (ESB2)

Expansion Slots

- Three PCI-Express x4 slots (x8 physical, x4 signal) (Slot 2, Slot 3, and Slot 5)
- Two PCI-Express x8 slots (x16 physical, x8 signal) (Slot 4 and Slot 6)
- One 64-bit PCI-X 133 MHz slot (Slot 1)
- One SIMLP (Supermicro Intelligent Management) add-on card slot (Slot 7)

BIOS

- 8 Mb Phoenix® Flash ROM
- DMI 2.3, PCI 2.2, ACPI 1.0, Plug and Play (PnP), and SMBIOS 2.3

PC Health Monitoring

- Onboard voltage monitors for CPU cores, chipset voltage, memory voltage, +1.8V, +3.3V, +3.3V Standby, +5V, +5V Standby, +12V, -12V and VBAT
- Fan status monitor with firmware control
- CPU/chassis temperature monitors
- Platform Environment Control Interface (PECI) ready
- CPU fan auto-off in sleep mode
- CPU slow-down on temperature overheat
- CPU thermal trip support for processor protection, power LED
- Power-up mode control for recovery from AC power loss
- Auto-switching voltage regulator for CPU cores
- System overheat/Fan Fail LED Indicator and control
- Chassis intrusion detection
- System resource alert via Supero Doctor III

ACPI Features

- Slow blinking LED for suspend state indicator
- Main switch override mechanism
- ACPI Power Management
- Keyboard Wakeup from Soft-off

Onboard I/O

- Six SATA2 ports (supporting RAID0, RAID1, RAID10, RAID5*) (*For the Windows Operating System only.)
- One SIMLP slot
- Intel 82563 Gigabit Ethernet controller supporting two Giga-bit LAN ports
- One EIDE Ultra DMA/100 bus master interface supports UDMA Mode 5, PIO Mode 4, ATA 100 with Compact Flash support
- One floppy port interface
- Two COM ports(1 header, 1 port)
- One EPP/ECP Parallel Port
- PS/2 mouse and PS/2 keyboard ports
- Up to five USB 2.0 (Universal Serial Bus) (2 ports, 3 Headers)
- ES1000 with 16 MB Graphic Controller
- Super I/O: Winbond W83627HF w/Hardware Monitor support: W83793, HECETA

Other

- External modem ring-on
- Wake-on-LAN (WOL)
- Wake-on-Ring (WOR)
- Console redirection
- Onboard Fan Speed Control by Thermal Management via BIOS

CD/Diskette Utilities

- BIOS flash upgrade utility and device drivers

Dimensions

- Ext. ATX 13.0" x 13.68" (330.2 mm x 347.5 mm)

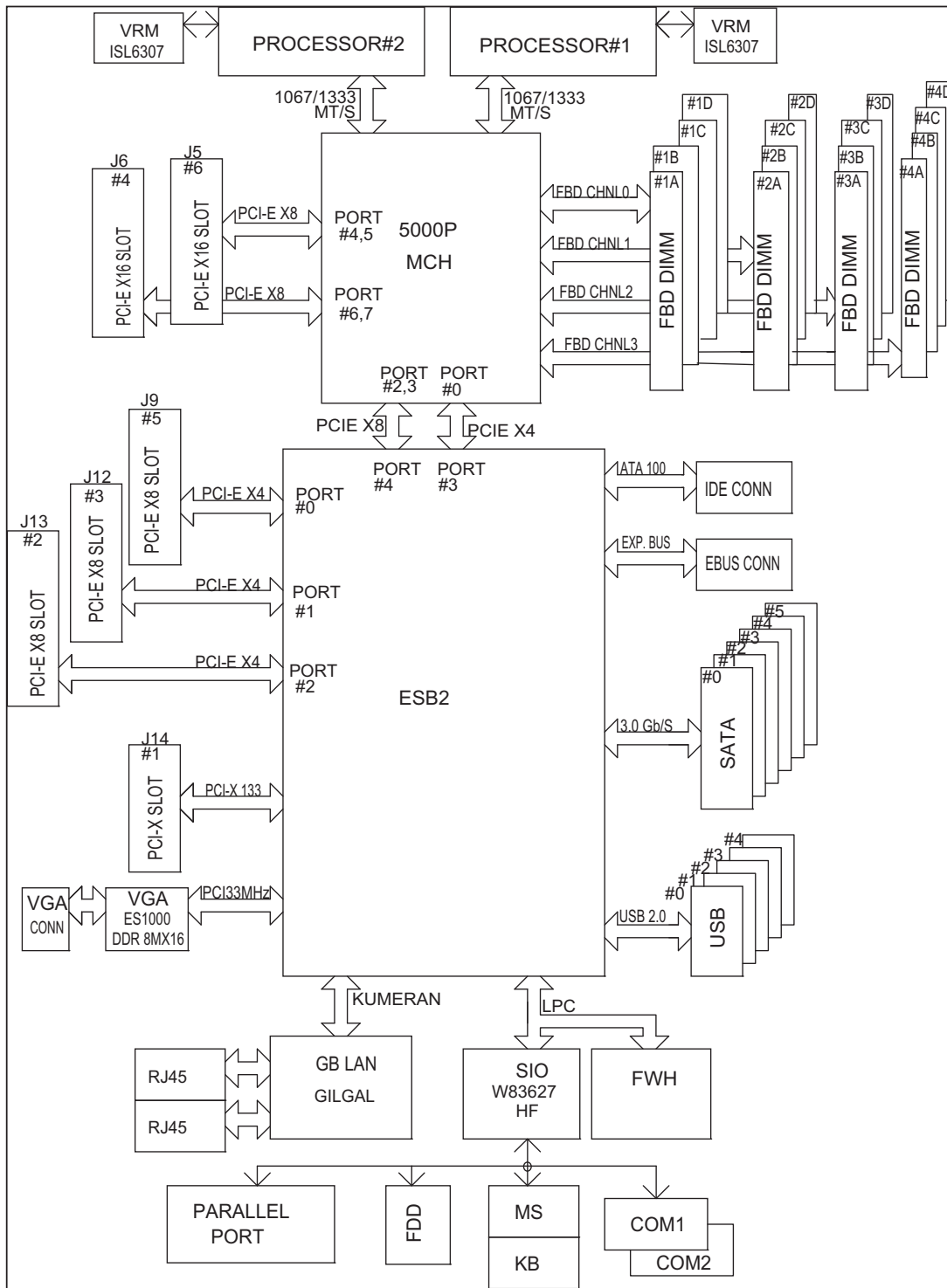

Block Diagram of the 5000P Chipset

Note: This is a general block diagram. Please see the previous Motherboard Features pages for details on the features of each motherboard.

1-2 Chipset Overview

Built upon the functionality and the capability of the 5000P chipset, the X7DBi+ motherboard provides the performance and feature set required for dual processor-based servers with configuration options optimized for communications, presentation, storage, computation or database applications. The 5000P chipset supports a single or dual Intel 64-bit Quad core/dual core processor(s) with front side bus speeds of up to 1.333 GHz. The chipset consists of the 5000P Memory Controller Hub (MCH) and the Enterprise South Bridge 2 (ESB2).

The 5000P MCH chipset is designed for symmetric multiprocessing across two independent front side bus interfaces. Each front side bus uses a 64-bit wide, 1.333 GHz data bus that transfers data at 10.7 GB/sec. In addition, the 5000P chipset offers a wide range of RAS features, including memory interface ECC, x4/x8 Single Device Data Correction, CRC, parity protection, memory mirroring and memory sparing.

The Xeon Dual Core Processors

*L1 Cache Size: Instruction Cache (32KB/16KB), Data Cache (32KB/24KB)

*L2 Cache Size: 4MB (2MB per core)

*Data Bus Transfer Rate: 8.5 GB/s

*Package: FC-LGA6/FC-LGA4, 771 Lands

The Xeon Quad Core Processors

*L1 Cache Size: Instruction Data Cache (32KB per core)

*L2 Cache Size: Shared 4MB per die (8MB Total Cache per processor)

*Data Bus Transfer Rate: 8.5 GB/s

1-3 Special Features

Recovery from AC Power Loss

The feature allows the user to set the power state after a power outage. You can select Power-Off for the system power to remain off after a power loss. Select Power-On for the system power to be turned on after a power loss. Select Last State to allow the system to resume its last state before the power loss. The default setting is **Last State**.

1-4 PC Health Monitoring

This section describes the PC health monitoring features of the X7DBi+. All have an onboard System Hardware Monitor chip that supports PC health monitoring.

Onboard Voltage Monitors for CPU Core, Memory Voltage, Chipset Voltage, +3.3V, +3.3V Standby,+5V, +5V Standby, +12V, -12V and VBAT

An onboard voltage monitor will scan these voltages continuously. Once a voltage becomes unstable, a warning is given or an error message is sent to the screen. Users can adjust the voltage thresholds to define the sensitivity of the voltage monitor.

Fan Status Monitor with Firmware Control

The PC health monitor can check the RPM status of the cooling fans. The onboard CPU and chassis fans are controlled by Thermal Management via BIOS (under Hardware Monitoring in the Advanced Setting).

Environmental Temperature Control

The thermal control sensor monitors the CPU temperature in real time and will turn on the thermal control fan whenever the CPU temperature exceeds a user-defined threshold. The overheat circuitry runs independently from the CPU. When it detects that the CPU temperature is too high, it will automatically turn on the thermal fan control to prevent any overheat damage to the CPU. The onboard chassis thermal circuitry can monitor the overall system temperature and alert users when the chassis temperature is too high.

CPU Fan Auto-Off in Sleep Mode

The CPU fan activates when the power is turned on. It continues to operate when the system enters a standby mode. When in the sleep mode, the CPU will not run at full power, thereby generating less heat.

System Resource Alert

This feature is available when used with Supero Doctor III in the Windows OS environment or used with Supero Doctor II in Linux. Supero Doctor is used to

notify the user of certain system events. For example, you can also configure Supero Doctor to provide you with warnings when the system temperature, CPU temperatures, voltages and fan speeds go beyond a pre-defined range.

1-5 ACPI Features

ACPI stands for Advanced Configuration and Power Interface. The ACPI specification defines a flexible and abstract hardware interface that provides a standard way to integrate power management features throughout a PC system, including its hardware, operating system and application software. This enables the system to automatically turn on and off peripherals such as CD-ROMs, network cards, hard disk drives and printers.

In addition to enabling operating system-directed power management, ACPI provides a generic system event mechanism for Plug and Play and an operating system-independent interface for configuration control. ACPI leverages the Plug and Play BIOS data structures while providing a processor architecture-independent implementation that is compatible with Windows 2000, Windows XP, and Windows 2003 Operating Systems.

Slow Blinking LED for Suspend-State Indicator

When the CPU goes into a suspend state, the chassis power LED will start blinking to indicate that the CPU is in suspend mode. When the user presses any key, the CPU will wake-up and the LED will automatically stop blinking and remain on.

Main Switch Override Mechanism

When an ATX power supply is used, the power button can function as a system suspend button to make the system enter a SoftOff state. The monitor will be suspended, and the hard drive will spin down. Pressing the power button again will cause the whole system to wake-up. During the SoftOff state, the ATX power supply provides power to keep the required circuitry in the system "alive". In case the system malfunctions and you want to turn off the power, just press and hold the power button for 4 seconds. This option can be set in the Power section of the BIOS Setup routine.

External Modem Ring-On

Wake-up events can be triggered by a device such as the external modem ringing when the system is in the SoftOff state. Note that external modem ring-on can only be used with an ATX 2.01 (or above) compliant power supply.

Wake-On-LAN (WOL)

Wake-On-LAN is defined as the ability of a management application to remotely power up a computer that is powered off. Remote PC setup, up-dates and asset tracking can occur after hours and on weekends so that daily LAN traffic is kept to a minimum and users are not interrupted. The motherboard has a 3-pin header

(WOL) to connect to the 3-pin header on a Network Interface Card (NIC) that has WOL capability. In addition, an onboard LAN controller can also support WOL without any connection to the WOL header. The 3-pin WOL header is to be used with a LAN add-on card only.

Note: Wake-On-LAN requires an ATX 2.01 (or above) compliant power supply.

1-6 Power Supply

As with all computer products, a stable power source is necessary for proper and reliable operation. It is even more important for processors that have high CPU clock rates.

The X7DBi+ can only accommodate 24-pin ATX power supplies. Although most power supplies generally meet the specifications required by the CPU, some are inadequate. In addition, the 12V 4-pin and the 12V 8-pin power connections are also required to ensure adequate power supply to the system. Also your power supply must supply 1.5A for the Ethernet ports.

Note: The + 12V 8-pin CPU Power Connector (JPW3) is also required to support Intel 64-bit CPUs. Failure to provide the extra power will result in CPU PWR Failure. See Section 2-5 for details on connecting the power supply.

It is strongly recommended that you use a high quality power supply that meets ATX power supply Specification 2.02 or above. It must also be SSI compliant. (Please refer to the Web site at <http://www.ssiforum.org/>). Additionally, in areas where noisy power transmission is present, you may choose to install a line filter to shield the computer from noise. It is recommended that you also install a power surge protector to help avoid problems caused by power surges.

1-7 Super I/O

The disk drive adapter functions of the Super I/O chip include a floppy disk drive controller that is compatible with industry standard 82077/765, a data separator, write pre-compensation circuitry, decode logic, data rate selection, a clock generator, drive interface control logic and interrupt and DMA logic. The wide range of functions integrated onto the Super I/O greatly reduces the number of components required for interfacing with floppy disk drives. The Super I/O supports 360 K, 720 K, 1.2 M, 1.44 M or 2.88 M disk drives and data transfer rates of 250 Kb/s, 500 Kb/s or 1 Mb/s. It also provides two high-speed, 16550 compatible serial communication ports (UARTs). Each UART includes a 16-byte send/receive FIFO, a programmable baud rate generator, complete modem control capability and a processor interrupt system. Both UARTs provide legacy speed with baud rate of up to 115.2 Kbps as well as an advanced speed with baud rates of 250 K, 500 K, or 1 Mb/s, which support higher speed modems.

The Super I/O supports one PC-compatible printer port (SPP), Bidirectional Printer Port (BPP), Enhanced Parallel Port (EPP) or Extended Capabilities Port (ECP).

The Super I/O provides functions that comply with ACPI (Advanced Configuration and Power Interface), which includes support of legacy and ACPI power management through an SMI or SCI function pin. It also features auto power management to reduce power consumption.

Notes

Chapter 2

Installation

2-1 Static-Sensitive Devices

Electrostatic Discharge (ESD) can damage electronic components. To prevent damage to your system board, it is important to handle it very carefully. The following measures are generally sufficient to protect your equipment from ESD.

Precautions

- Use a grounded wrist strap designed to prevent static discharge.
- Touch a grounded metal object before removing the board from the antistatic bag.
- Handle the board by its edges only; do not touch its components, peripheral chips, memory modules or gold contacts.
- When handling chips or modules, avoid touching their pins.
- Put the motherboard and peripherals back into their antistatic bags when not in use.
- For grounding purposes, make sure your computer chassis provides excellent conductivity between the power supply, the case, the mounting fasteners and the motherboard.
- Use only the correct type of onboard CMOS battery as specified by the manufacturer. Do not install the onboard battery upside down to avoid possible explosion.

Unpacking

The motherboard is shipped in antistatic packaging to avoid static damage. When unpacking the board, make sure the person handling it is static protected.

2-2 Processor and Heatsink Installation



When handling the processor package, avoid placing direct pressure on the label area of the fan.

- Notes:**
1. Always connect the power cord last and always remove it before adding, removing or changing any hardware components. Make sure that you install the processor into the CPU socket before you install the CPU heatsink.
 2. Intel's boxed Xeon CPU package contains the CPU fan and heatsink assembly. If you buy a CPU separately, make sure that you use only Intel-certified multi-directional heatsink and fan.
 3. The Intel Xeon LGA 771 heatsink and fan comes with a push-pin design and no tool is needed for installation.
 4. Make sure to install the motherboard into the chassis before you install the CPU heatsink and fan.)
 5. When purchasing an LGA 771 CPU or when receiving a motherboard with an LGA 771 CPU pre-installed, make sure that the CPU plastic cap is in place and none of the CPU pins are bent; otherwise, contact the retailer immediately.
 6. Refer to the MB Features Section for more details on CPU support.

Installation of the LGA771 Processor

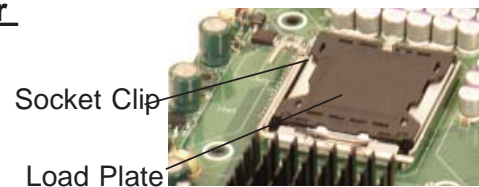

1. Press the socket clip to release the load plate, which covers the CPU socket, from its locking position.



2. Gently lift the socket clip to open the load plate.

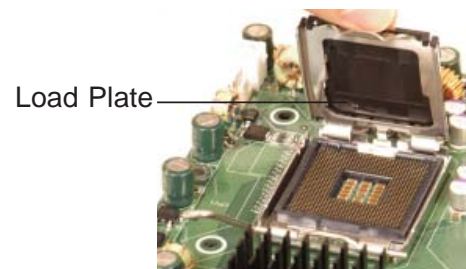

3. Use your thumb and your index finger to hold the CPU at the North Center Edge and the South Center Edge of the CPU.

4. Align CPU Pin1 (the CPU corner marked with a triangle) against the socket corner that is marked with a triangle cutout.

5. Align the CPU key that is the semi-circle cutout below a gold dot against the socket key, the Notch on the same side of the triangle cutout on the socket.

6. Once aligned, carefully lower the CPU straight down into the socket. (**Do not drop the CPU on the socket. Do not move the CPU horizontally or vertically. Do not rub the CPU against the surface or against any pins of the socket to avoid damage to the CPU or the socket.)

7. With the CPU inside the socket, inspect the four corners of the CPU to make sure that the CPU is properly installed.

8. Use your thumb to gently push the socket clip down to the clip lock.

9. If the CPU is properly installed into the socket, the plastic cap will be automatically released from the load plate when the clip is pushed in the clip lock. Remove the plastic cap from the motherboard.

 ***Warning:** Please save the plastic cap. The motherboard must be shipped with the plastic cap properly installed to protect the CPU socket pins. Shipment without the plastic cap properly installed will cause damage to the socket pins.

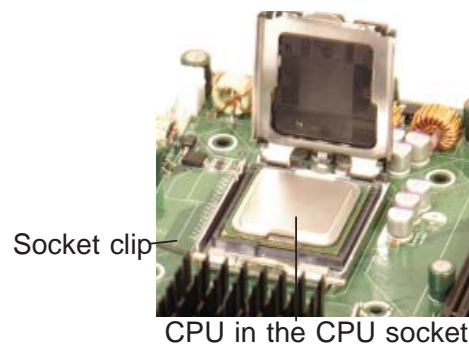
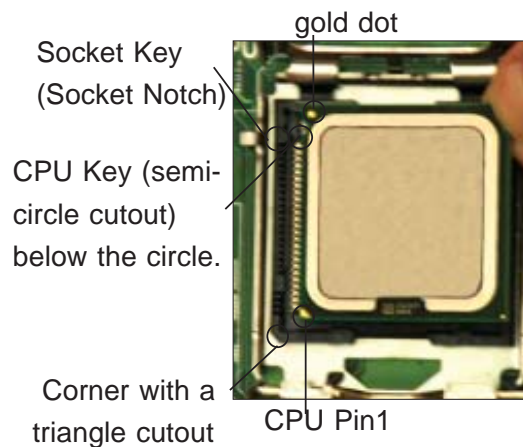

Plastic cap is released from the load plate if the CPU is properly installed.



Installation of the Heatsink

CEK Heatsink Installation

1. Do not apply any thermal grease to the heatsink or the CPU die because the required amount has already been applied.

2. Place the heatsink on top of the CPU so that the four mounting holes are aligned with those on the retention mechanism.

3. Screw in two diagonal screws (ie the #1 and the #2 screws) until just snug (-do not fully tighten the screws to avoid possible damage to the CPU.)

4. Finish the installation by fully tightening all four screws.

CEK Passive Heatsink

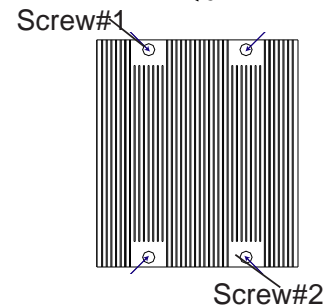
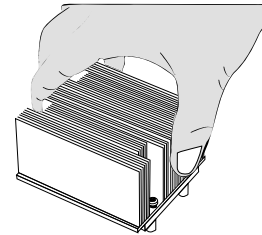
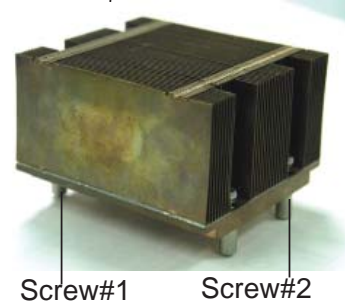

To Un-install the Heatsink



Warning: We do not recommend that the CPU or the heatsink be removed. However, if you do need to uninstall the heatsink, please follow the instructions below to uninstall the heatsink to prevent damage done to the CPU or the CPU socket.

1. Unscrew and remove the heatsink screws from the motherboard in the sequence as show in the picture on the right.

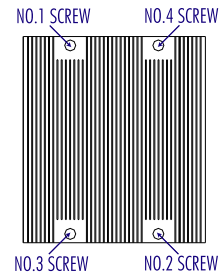

2. Hold the heatsink as shown in the picture on the right and gently wriggle the heatsink to loosen it from the CPU. (Do not use excessive force when wriggling the heatsink!!)

3. Once the CPU is loosened, remove the heatsink from the CPU socket.

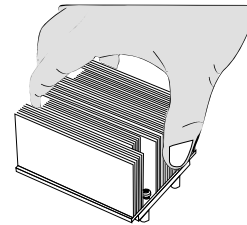

4. Clean the surface of the CPU and the heatsink to get rid of the old thermal grease. Reapply the proper amount of thermal grease on the surface before you re-install the CPU and the heatsink.

Mounting the Motherboard in the Chassis

All motherboards have standard mounting holes to fit different types of chassis. Make sure that the locations of all the mounting holes for both motherboard and chassis match. Make sure that the metal standoffs click in or are screwed in tightly. Then, use a screwdriver to secure the motherboard onto the motherboard tray. **Note:** some components are very close to the mounting holes. Please take precautionary measures to prevent damage done to these components when you install the motherboard to the chassis.

2-3 Installing DIMMs

Note: Check the Supermicro web site for recommended memory modules.

CAUTION



Exercise extreme care when installing or removing DIMM modules to prevent any possible damage. Also note that the memory is interleaved to improve performance.

DIMM Installation

1. Insert the desired number of DIMMs into the memory slots, starting with DIMM #1A. The memory scheme is interleaved so you must install four modules at a time, beginning with DIMM #1A, DIMM #2A, DIMM #3A, then DIMM #4A and so on. For optimal memory performance, please install four modules at a time with the maximum of 16 modules. (See the Memory Installation Table Below.)
2. Insert each DIMM module vertically into its slot. Pay attention to the notch along the bottom of the module to prevent inserting the DIMM module incorrectly.
3. Gently press down on the DIMM module until it snaps into place in the slot. Repeat for all modules (see step 1 above).

Memory Support

The X7DBi+ supports up to 64 GB fully buffered (FBD) ECC DDR 2 533/667 in 16 DIMMs. Populating DIMM modules with pairs of memory modules that are of the same size and same type in **both Branch 0 and Branch 1** will result in interleaved memory. (See the table below.)

Note 1: Due to OS limitations, some operating systems may not show more than 4 GB of memory.

DIMM Module Population Configuration

To optimize memory support, follow the table below for memory installation:

Optimized DIMM Population Table																
	Branch 0								Branch 1							
Number of DIMMs	Bank 1 (Channel 0)				Bank 2 (Channel 1)				Bank 3 (Channel 2)			Bank 4 (Channel 3)				
2 DIMMs	1A	---	---	---	2A	---	---	---	---	---	---	---	---	---	---	
4 DIMMs	1A	---	---	---	2A	---	---	---	3A	---	---	---	4A	---	---	
8 DIMMs	1A	1B	---	---	2A	2B	---	---	3A	3B	---	---	4A	4B	---	
12 DIMMs	1A	1B	1C	---	2A	2B	2C	---	3A	3B	3C	---	4A	4B	4C	---
16 DIMMs	1A	1B	1C	1D	2A	2B	2C	2D	3A	3B	3C	3D	4A	4B	4C	4D
(* Notes: i. DIMM slot# specified: DIMM slot to be populated; “---”: DIMM slot not to be populated. ii. Both FBD 533 MHz and 667MHz DIMMs are supported; however, you need to use the memory modules of the same speed and of the same type on a motherboard. iii. Interleaved memory is supported when pairs of DIMM modules are installed. For optimal memory performance, please install pairs of memory modules in both Branch 0 and Branch 1 . iv. For memory to work properly, you need to follow the restrictions listed above.)																

Note 2: Due to memory allocation to system devices, memory remaining available for operational use will be reduced when 4 GB of RAM is used. The reduction in memory availability is disproportional. (See the Memory Availability Table below.)

Possible System Memory Allocation & Availability		
System Device	Size	Physical Memory Remaining (-Available) (4 GB Total System Memory)
Firmware Hub flash memory (System BIOS)	1 MB	3.99GB
Local APIC	4 KB	3.99GB
Area Reserved for the chipset	2 MB	3.99GB
I/O APIC (4 Kbytes)	4 KB	3.99GB
PCI Enumeration Area 1	256 MB	3.76GB
PCI Express (256 MB)	256 MB	3.51GB
PCI Enumeration Area 2 (if needed) -Aligned on 256-MB boundary-	512 MB	3.01GB
VGA Memory	16 MB	2.85GB
TSEG	1 MB	2.84GB
Memory available for the OS & other applications		2.84GB

Installing and Removing DIMMs

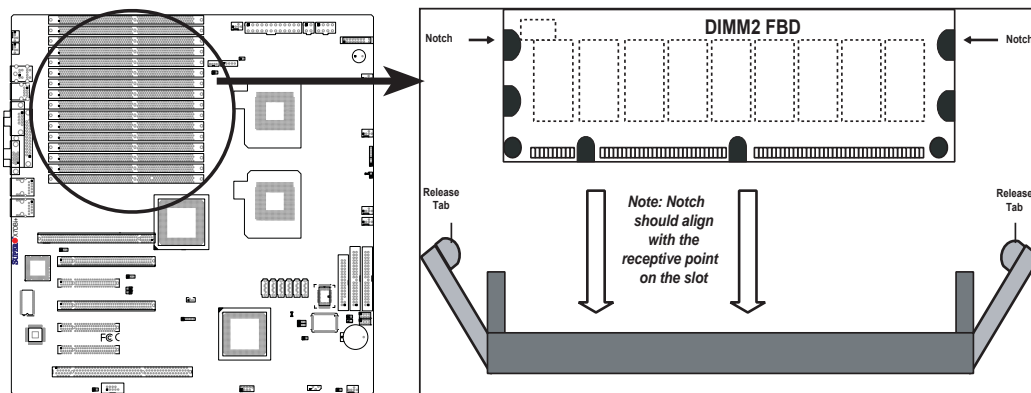

To Install: Insert module vertically and press down until it snaps into place. Pay attention to the alignment notch at the bottom.

To Remove:

Use your thumbs to gently push the release tabs near both ends of the module. This should release it from the slot.

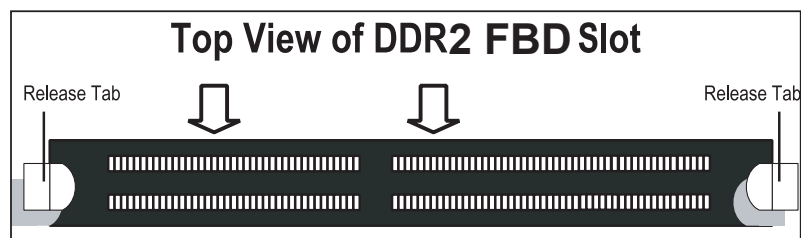

2-4 Control Panel Connectors/IO Ports

The I/O ports are color coded in conformance with the PC 99 specification. See the figure below for the colors and locations of the various I/O ports.

A. Back Panel Connectors/IO Ports

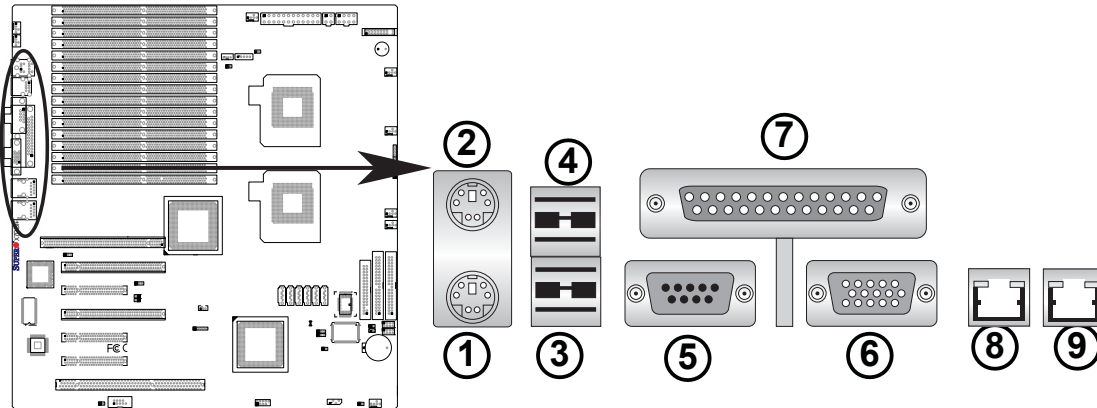

Figure 2-3. Back Panel I/O Port Locations and Definitions

Back Panel Connectors

1. Keyboard (Purple)
2. PS/2 Mouse (Green)
3. Back Panel USB Port 0
4. Back Panel USB Port 1
5. COM Port 1 (Turquoise)
6. VGA Port (Blue)
7. Parallel Port (Printer)
8. Gigabit LAN 1
9. Gigabit LAN 2

(*See Section 2-5 for details.)

B. Front Control Panel

JF1 contains header pins for various buttons and indicators that are normally located on a control panel at the front of the chassis. These connectors are designed specifically for use with Supermicro server chassis. See the figure below for the descriptions of the various control panel buttons and LED indicators. Refer to the following section for descriptions and pin definitions.

JF1 Header Pins

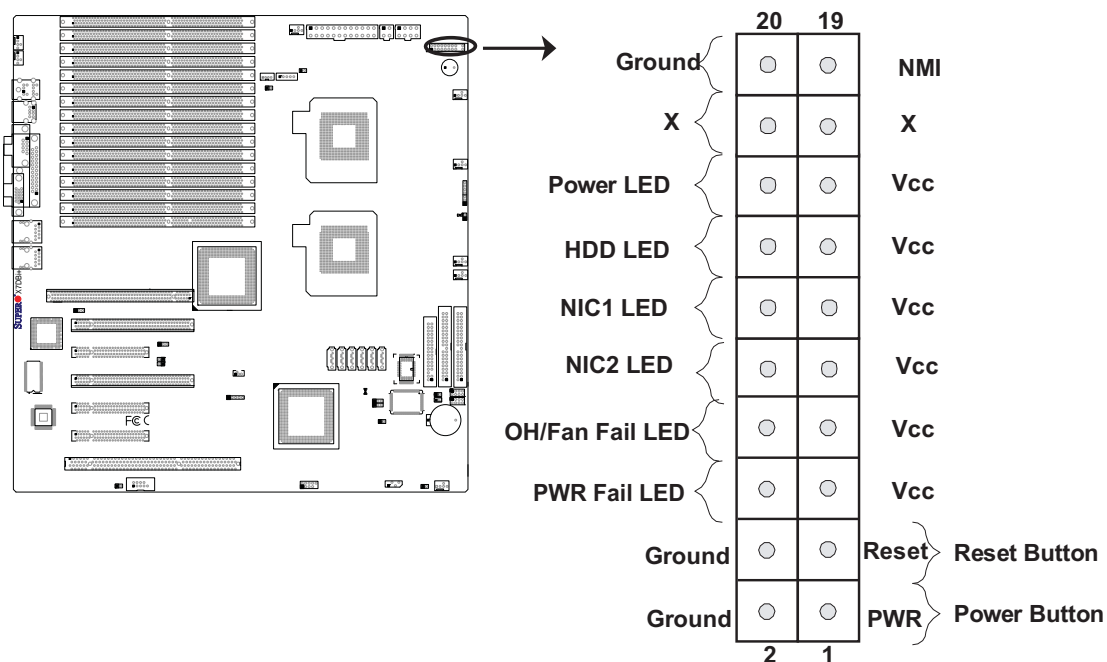

C. Front Control Panel Pin Definitions

NMI Button

The non-maskable interrupt button header is located on pins 19 and 20 of JF1. Refer to the table on the right for pin definitions.

NMI Button Pin Definitions (JF1)	
Pin#	Definition
19	Control
20	Ground

Power LED

The Power LED connection is located on pins 15 and 16 of JF1. Refer to the table on the right for pin definitions.

Power LED Pin Definitions (JF1)	
Pin#	Definition
15	+5V
16	Ground

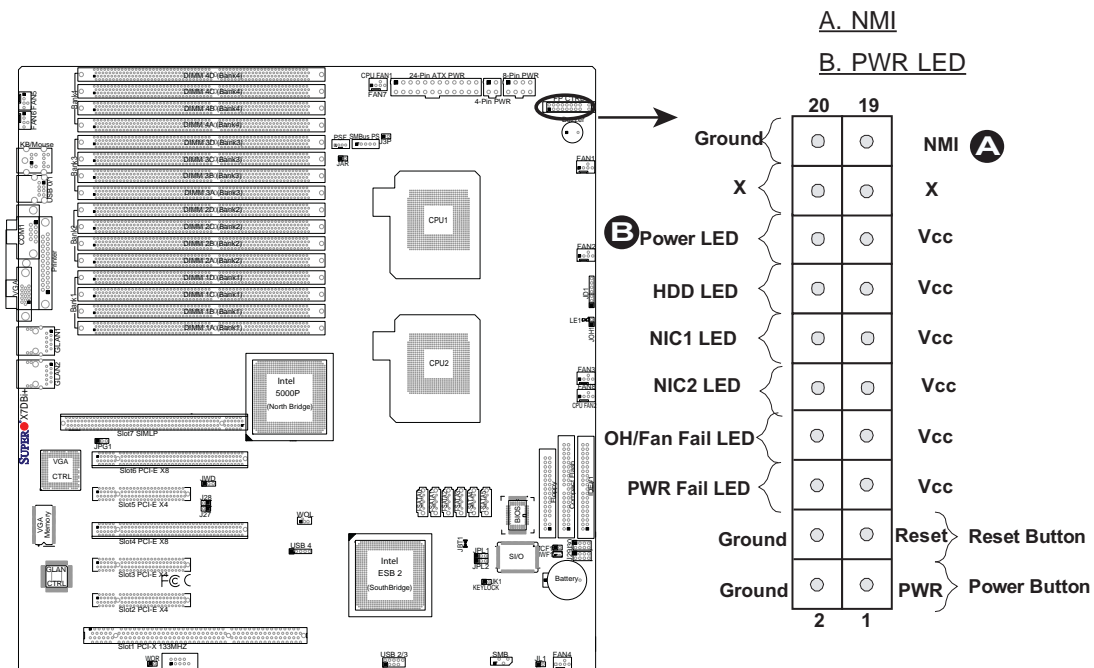

HDD LED

The HDD LED connection is located on pins 13 and 14 of JF1. Attach a hard drive LED cable here to display disk activity (for any hard drives on the system, including Serial ATA and IDE). See the table on the right for pin definitions.

HDD LED Pin Definitions (JF1)	
Pin#	Definition
13	+5V
14	HD Active

NIC1/NIC2 LED Indicators

The NIC (Network Interface Controller) LED connection for GLAN port1 is located on pins 11 and 12 of JF1 and the LED connection for GLAN Port2 is on Pins 9 and 10. Attach the NIC LED cables to display network activity. Refer to the table on the right for pin definitions.

GLAN1/2 LED Pin Definitions (JF1)	
Pin#	Definition
9/11	Vcc
10/12	Ground

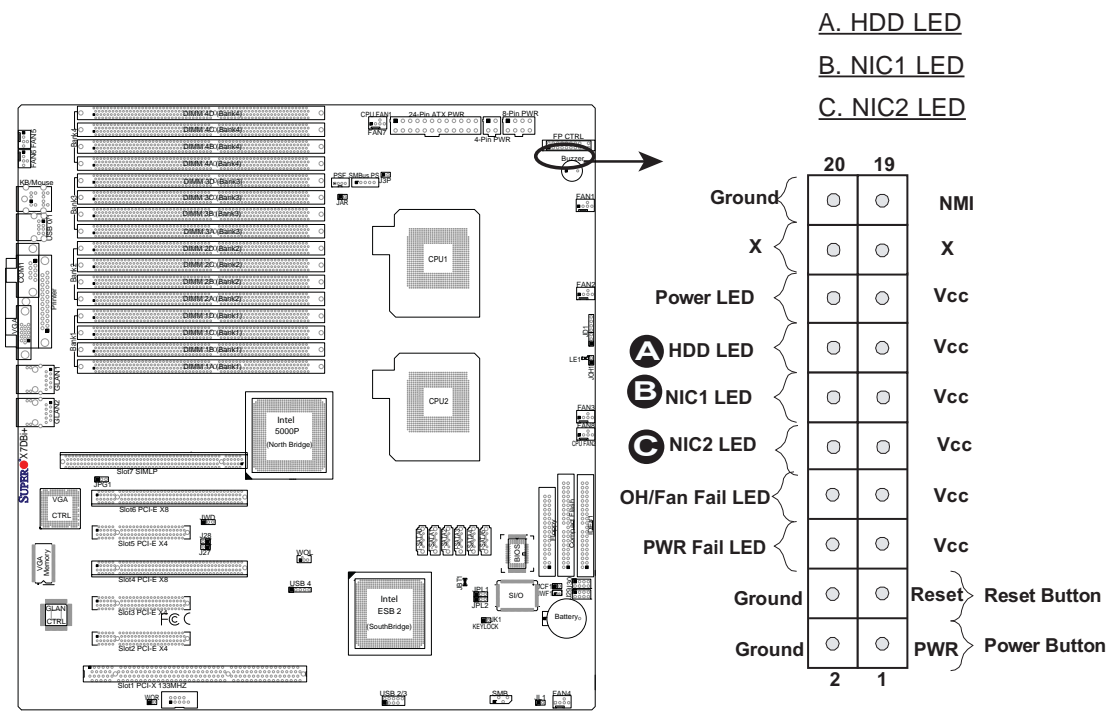

Overheat/Fan Fail LED (OH)

Connect an LED to the OH/Fan Fail connection on pins 7 and 8 of JF1 to provide advanced warnings of chassis overheating or fan failure. Refer to the table on the right for pin definitions.

OH/Fan Fail LED Pin Definitions (JF1)

Pin#	Definition
7	Vcc
8	Ground

OH/Fan Fail Indicator Status

State	Definition
Off	Normal
On	Overheat
Flashing	Fan Fail

Power Fail LED

The Power Fail LED connection is located on pins 5 and 6 of JF1. Refer to the table on the right for pin definitions.

PWR Fail LED Pin Definitions (JF1)

Pin#	Definition
5	Vcc
6	Ground

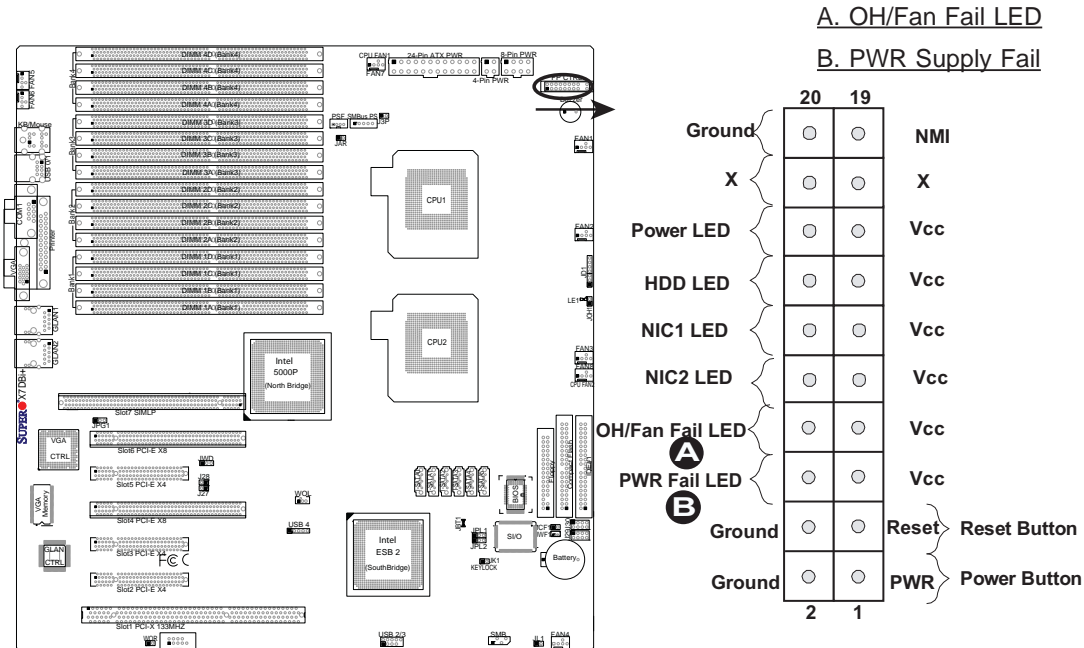

Reset Button

The Reset Button connection is located on pins 3 and 4 of JF1. Attach it to the hardware reset switch on the computer case. Refer to the table on the right for pin definitions.

Reset Button Pin Definitions (JF1)	
Pin#	Definition
3	Reset
4	Ground

Power Button

The Power Button connection is located on pins 1 and 2 of JF1. Momentarily contacting both pins will power on/off the system. This button can also be configured to function as a suspend button (with a setting in BIOS - see Chapter 4). To turn off the power when set to suspend mode, press the button for at least 4 seconds. Refer to the table on the right for pin definitions.

Power Button Pin Definitions (JF1)	
Pin#	Definition
1	Signal
2	+3V Standby

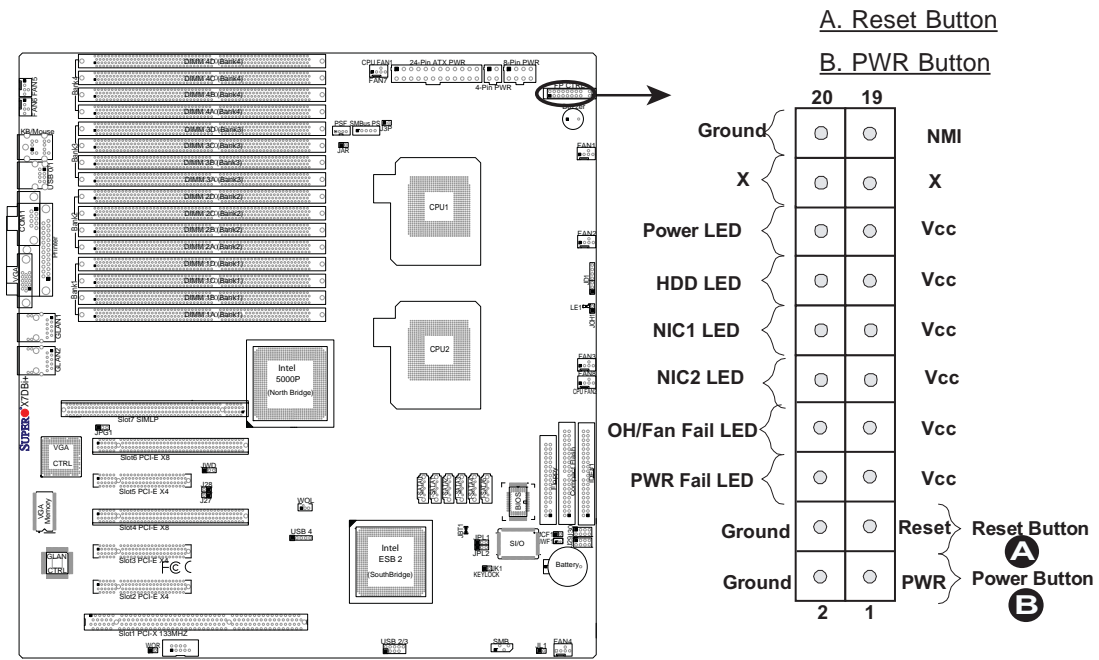

2-5 Connecting Cables

ATX Power Connector

There are a 24-pin main power supply connector(JPW1) and an 8-pin CPU PWR connector (JPW3) on the motherboard. These power connectors meet the SSI EPS 12V specification. The 4-pin 12V PWR supply is required to provide adequate power to the system. See the table on the right for pin definitions. For the 8-pin PWR (JPW3), please refer to the item listed below.

ATX Power 20-pin Connector Pin Definitions			
Pin#	Definition	Pin #	Definition
13	+3.3V	1	+3.3V
14	-12V	2	+3.3V
15	COM	3	COM
16	PS_ON	4	+5V
17	COM	5	COM
18	COM	6	+5V
19	COM	7	COM
20	Res (NC)	8	PWR_OK
21	+5V	9	5VSB
22	+5V	10	+12V
23	+5V	11	+12V
24	COM	12	+3.3V

Processor Power Connector

In addition to the Primary ATX power connector (above), the 12V 8-pin CPU PWR connector at JPW3 must also be connected to your power supply. See the table on the right for pin definitions.

12V 4-pin Power Connector Pin Definitions

Pins	Definition
1 and 2	Ground
3 and 4	+12V

Required Connection

12V 8-pin Power Connector Pin Definitions

Pins	Definition
1 through 4	Ground
5 through 8	+12V

Required Connection

- A. 24-pin ATX PWR
- B. 8-pin Processor PWR
- C. 4-pin PWR

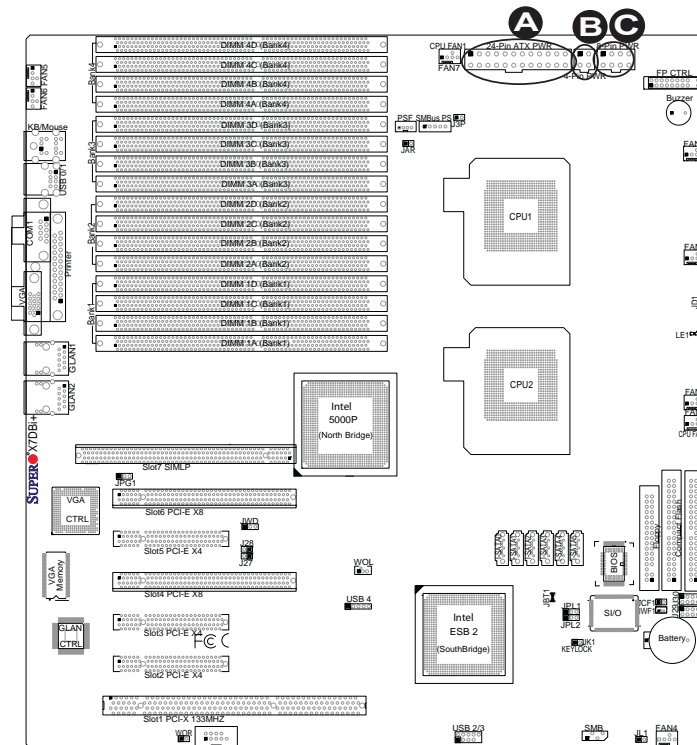

Universal Serial Bus (USB)

There are five USB 2.0 (Universal Serial Bus) ports/headers on the motherboard. Two of them are Back Panel USB ports (USB#0/1:JUSB1), and the other three are Front Panel Accessible USB headers (USB#2/3:JUSB2, USB#4: JUSB3). See the tables on the right for pin definitions.

Back Panel USB (USB0/1)	
Pin#	Definitions
1	+5V
2	PO-
3	PO+
4	Ground
5	N/A

Front Panel USB Pin Definitions			
USB2/4		USB3	
Pin #	Definition	Pin #	Definition
1	+5V	1	+5V
2	PO-	2	PO-
3	PO+	3	PO+
4	Ground	4	Ground
5	Key	5	No connection

Chassis Intrusion

A Chassis Intrusion header is located at JL1 on the motherboard. Attach the appropriate cable from the chassis to inform you of a chassis intrusion when the chassis is opened.

Chassis Intrusion Pin Definitions (JL1)	
Pin#	Definition
1	Intrusion Input
2	Ground

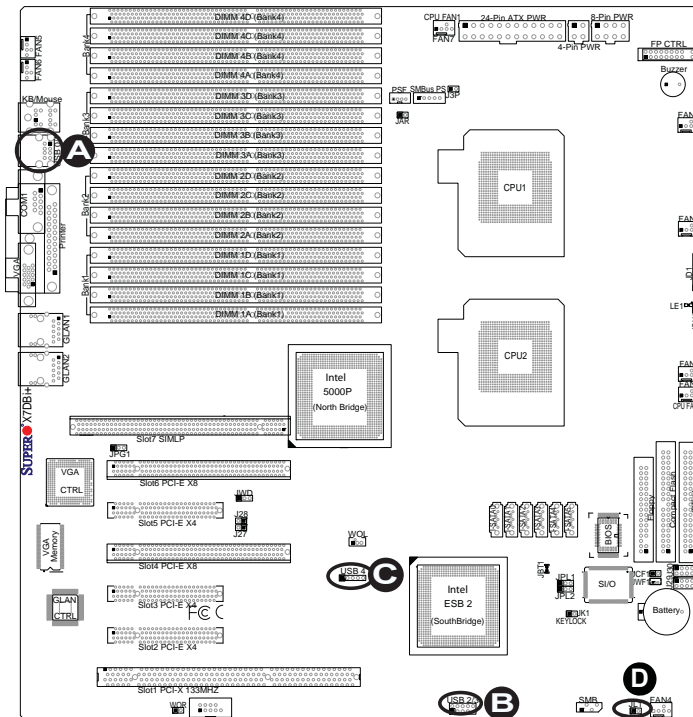

- A. Backpanel USB 0-1
- B. Front Panel USB 2-3
- C. Front Panel USB 4
- D. Chassis Intrusion

Fan Headers

The X7DBi+ has six chassis/system fan headers (Fan1 to Fan6) and two CPU Fans (Fans 7/8). (**Note:** Fans 5/6/7/8 are 4-pin fans. However, Pins 1-3 of these fan headers are backward compatible with the traditional 3-pin fans. *The onboard fan speeds are controlled by Thermal Management via BIOS Hardware Monitor in the Advanced Setting. **Note:** When using Thermal Management setting, please use all 3-pin fans or all 4-pin fans on the motherboard. (The Default setting for Fan Speed Control in the BIOS is Disabled.)

Fan Header Pin Definitions (Fan1-8)	
Pin#	Definition
1	Ground
2	+12V
3	Tachometer
4	PWR Modulation

Keylock

The keyboard lock connection is designated JK1. Utilizing this header allows you to inhibit any actions made on the keyboard, effectively "locking" it.

Keylock Pin Definitions	
Pin#	Definition
1	Ground
2	Keylock R-N

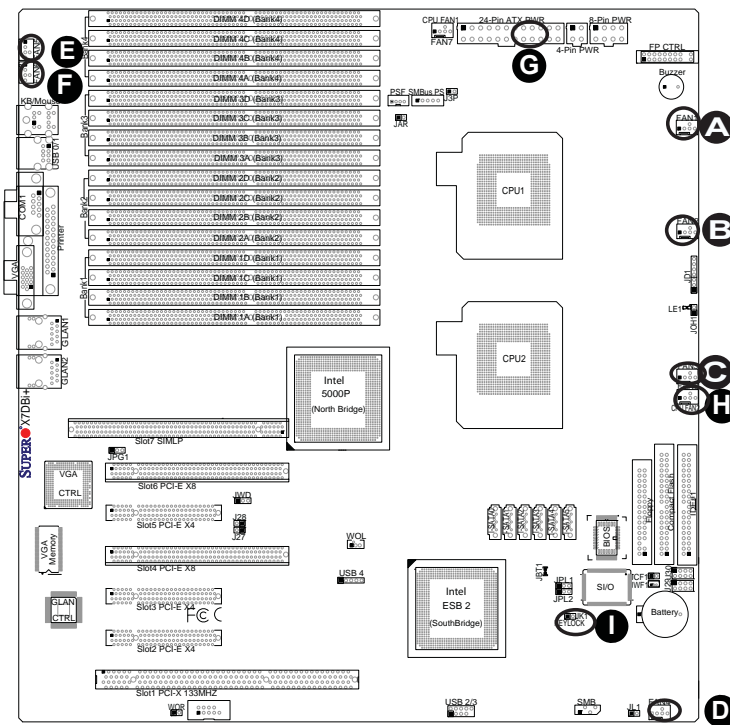

- A. Fan 1
- B. Fan 2
- C. Fan 3
- D. Fan 4
- E. Fan 5
- F. Fan 6
- G. Fan 7 (CPU Fan 1)
- H. Fan 8 (CPU Fan 2)
- I. Keylock

ATX PS/2 Keyboard and PS/2 Mouse Ports

The ATX PS/2 keyboard and the PS/2 mouse are located at JKM1. The mouse port is above the keyboard port. See the table on the right for pin definitions.

PS/2 Keyboard and Mouse Port Pin Definitions	
Pin#	Definition
1	Data
2	NC
3	Ground
4	VCC
5	Clock
6	NC

Serial Ports

COM1 is a connector located on the IO Backpanel, and COM2 is a header located at JCOM2. See the table on the right for pin definitions.

Serial Port Pin Definitions (COM1/COM2)			
Pin #	Definition	Pin #	Definition
1	CD	6	DSR
2	RD	7	RTS
3	TD	8	CTS
4	DTR	9	RI
5	Ground	10	NC

(Pin 10 is available on COM2 only. NC: No Connection.)

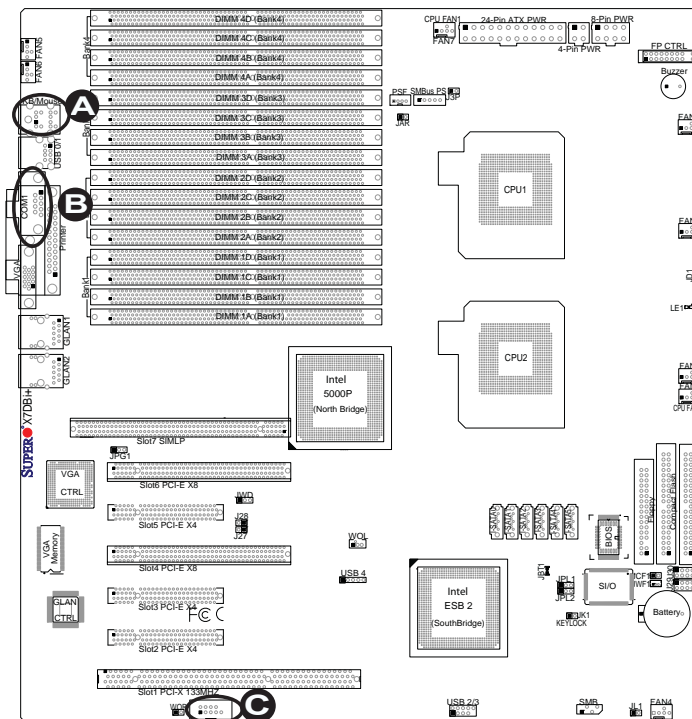

A. Keyboard/Mouse

B. COM1

C. COM2

Wake-On-Ring

The Wake-On-Ring header is designated JWOR1. This feature allows your computer to "wake up" when receiving an incoming call to the modem when the system is in suspend mode. See the table on the right for pin definitions. You must have a Wake-On-Ring card and cable to use this feature.

Wake-On-Ring Pin Definitions (WOR)	
Pin#	Definition
1	Ground
2	Wake-up

Wake-On-LAN

The Wake-On-LAN header is located at JWOL1 on the motherboard. See the table on the right for pin definitions. (You must also have a LAN card with a Wake-On-LAN connector and cable to use this feature.)

Wake-On-LAN Pin Definitions (WOL)	
Pin#	Definition
1	+5V Standby
2	Ground
3	Wake-up

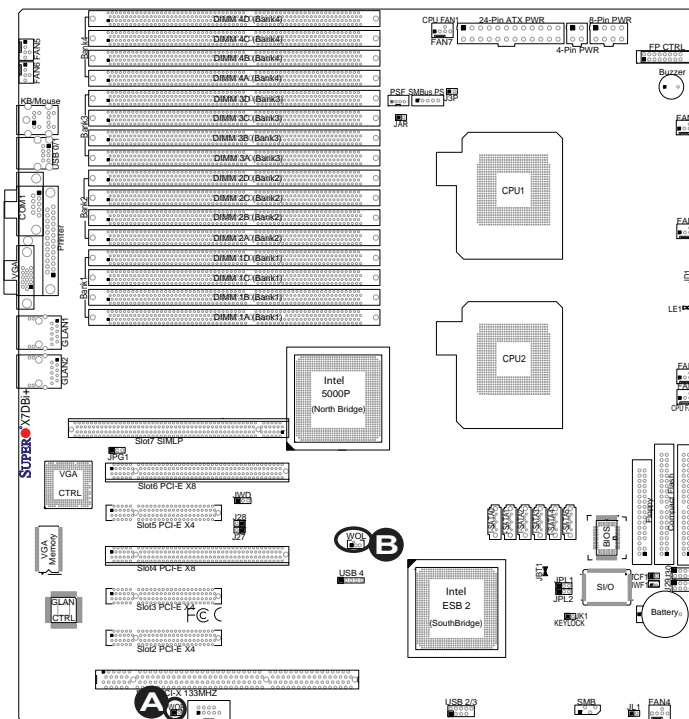

A. WOR

B. WOL

GLAN 1/2 (Giga-bit Ethernet Ports)

Two G-bit Ethernet ports are designated JLAN1 and JLAN2 on the IO backplane. These ports accept RJ45 type cables.



Power LED/Speaker

On the JD1 header, pins 1-3 are for a power LED and pins 4-7 are for the speaker. See the table on the right for speaker pin definitions. **Note:** The speaker connector pins are for use with an external speaker. If you wish to use the onboard speaker, you should close pins 6-7 with a jumper.

Speaker Connector	
Pin Setting	Definition
Pins 6-7	Internal Speaker
Pins 4-7	External Speaker

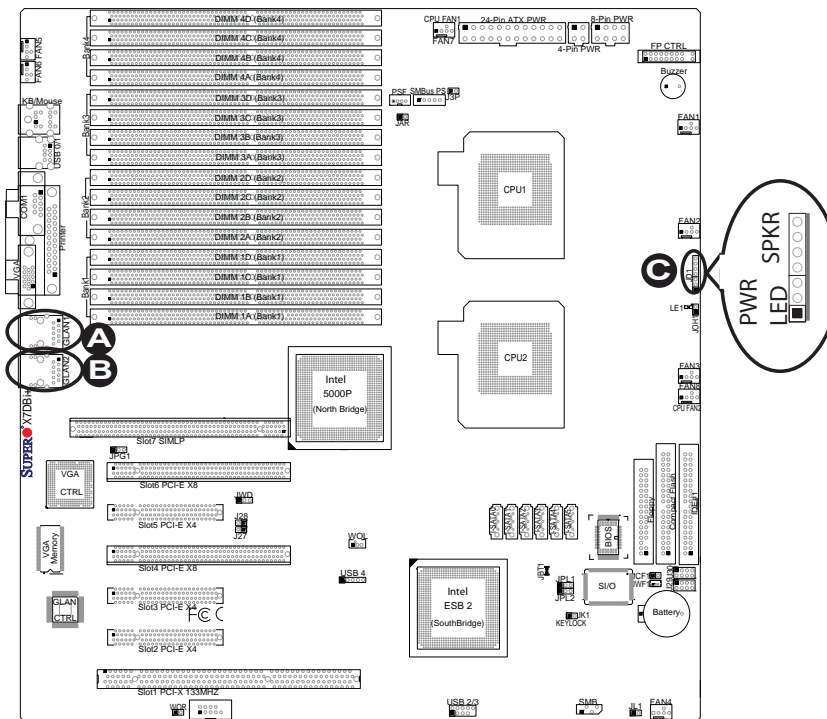

- A. GLAN1
- B. GLAN2
- C. PWR LED/Speaker

Power Fault (PWR Supply Failure)

Connect a cable from your power supply to the Power Fail header (JP3) to provide warnings of power supply failure. This warning signal is passed through the PWR_LED pin to indicate of a power failure on the chassis. See the table on the right for pin definitions.

PWR Supply Fail LED Pin Definitions	
Pin#	Definition
1	PWR 1: Fail
2	PWR 2: Fail
3	PWR 3: Fail
4	Signal: Alarm Reset

Note: This feature is only available when using Supermicro redundant power supplies.

Alarm Reset

If three power supplies are installed and Alarm Reset (JAR) is enabled, the system will notify you when any of the three power modules fails. Connect JAR to a micro-switch to enable you to turn off the alarm that is activated when a power module fails. See the table on the right for pin definitions.

Alarm Reset	
Pin Setting	Definition
Pin 1	Ground
Pin 2	+5V

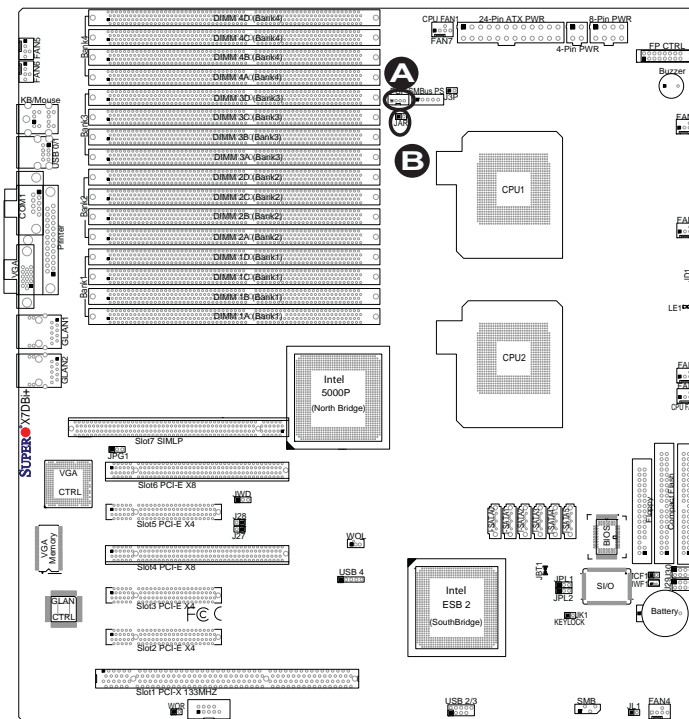

- A. Power Fault
- B. Alarm Reset

SMB

A System Management Bus header is located at J18. Connect the appropriate cable here to utilize SMB on your system.

SMB Header Pin Definitions	
Pin#	Definition
1	Data
2	Ground
3	Clock
4	No Connection

SMBus PS (I²C) Connector

Power Supply SMB (I²C) Connector (J17) monitors the status of power supply, fans and system temperatures. See the table on the right for pin definitions.

PWR SMB Pin Definitions	
Pin#	Definition
1	Clock
2	Data
3	PWR Fail
4	Ground
5	+3.3V

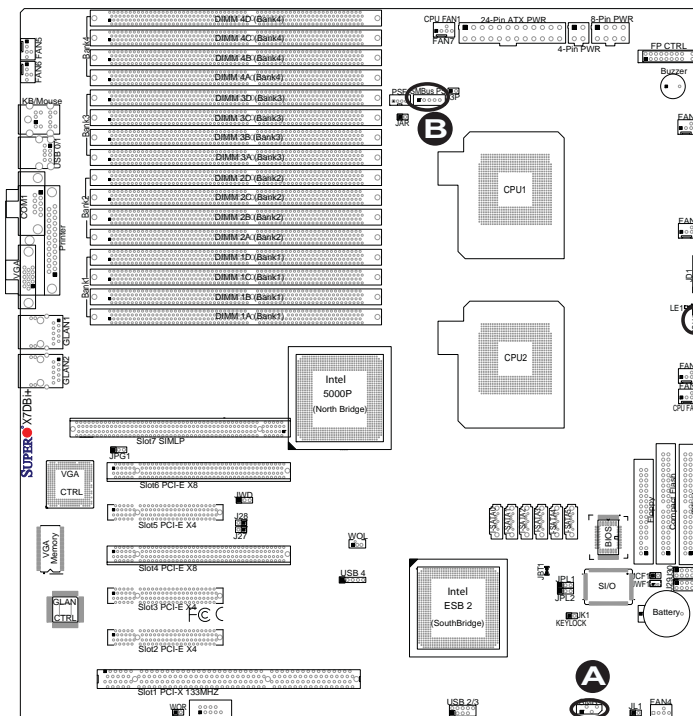

A. SMB (J18)

B. PWR SMB (J17)

T-SGPIO Headers

There are two T-SGPIO (Serial General Purpose Input/Output) headers located at (J29, J30) on the motherboard. These headers support serial link interfaces for the onboard SATA connectors. See the table on the right for pin definitions. Refer to the board layout below for the location.

SGPIO Pin Definitions			
Pin#	Definition	Pin	Definition
1	*NC	2	*NC
3	Ground	4	Data
5	Load	6	Ground
7	*NC	8	*NC

Note: NC= No Connections

VGA Connector

A VGA connector (J15) is located next to COM1 on the IO backplane. Refer to the board layout below for the location.

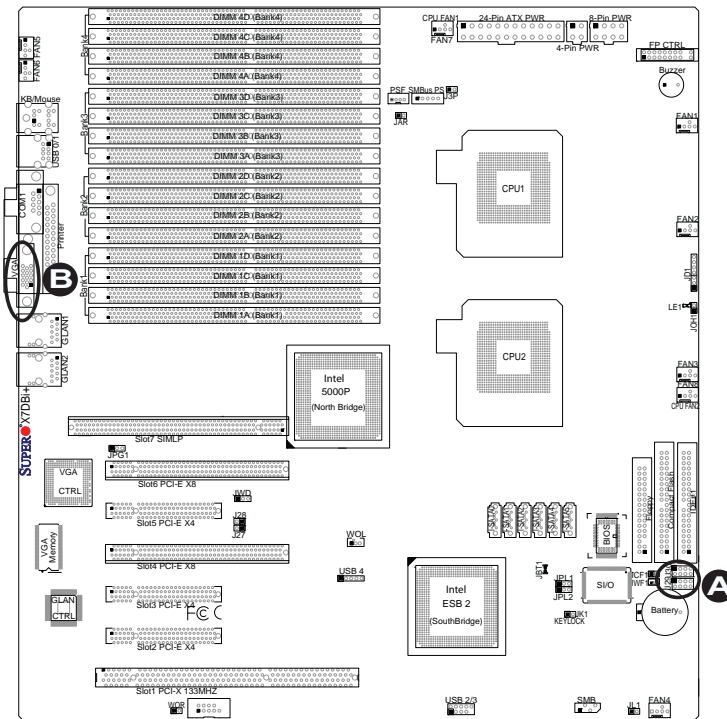

A. T-SGPIO 1/2

B. VGA

Compact Flash Card PWR Connector

A Compact Flash Card Power Connector is located at JWF1. For the Compact Flash Card or the Compact Flash Jumper (JCF1) to work properly, please connect the Compact Flash Card power cable to JWF1 first. Refer to the board layout below for the location.

Compact Flash Card PWR Connector	
Jumper	Definition
On	Compact Flash Power On
Off	Compact Flash Power Off

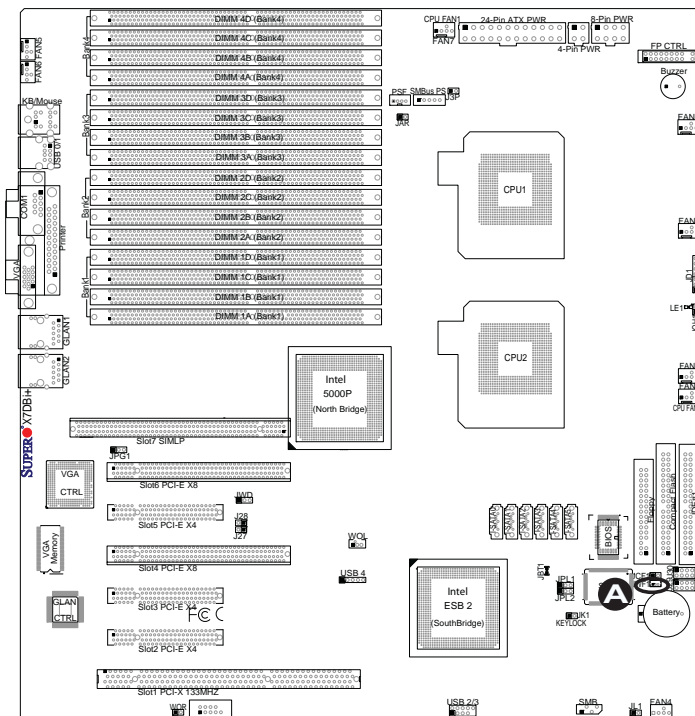

A. Compact Flash PWR

2-6 Jumper Settings

Explanation of Jumpers

To modify the operation of the motherboard, jumpers can be used to choose between optional settings. Jumpers create shorts between two pins to change the function of the connector. Pin 1 is identified with a square solder pad on the printed circuit board. See the motherboard layout pages for jumper locations.

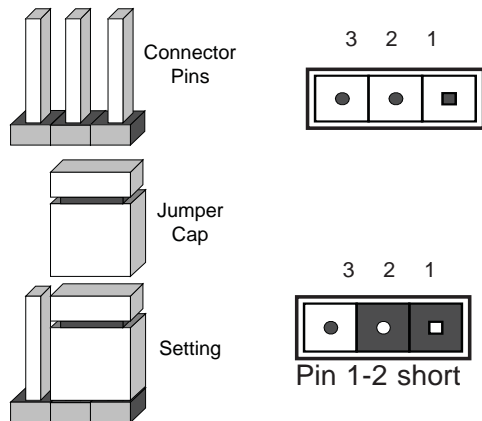

Note: On two pin jumpers, "Closed" means the jumper is on and "Open" means the jumper is off the pins.

GLAN Enable/Disable

JPL1/JPL2 enable or disable the GLAN Port1/GLAN Port2 on the motherboard. See the table on the right for jumper settings. The default setting is enabled.

GLAN Enable	
Pin#	Definition
1-2	Enabled (*default)
2-3	Disabled

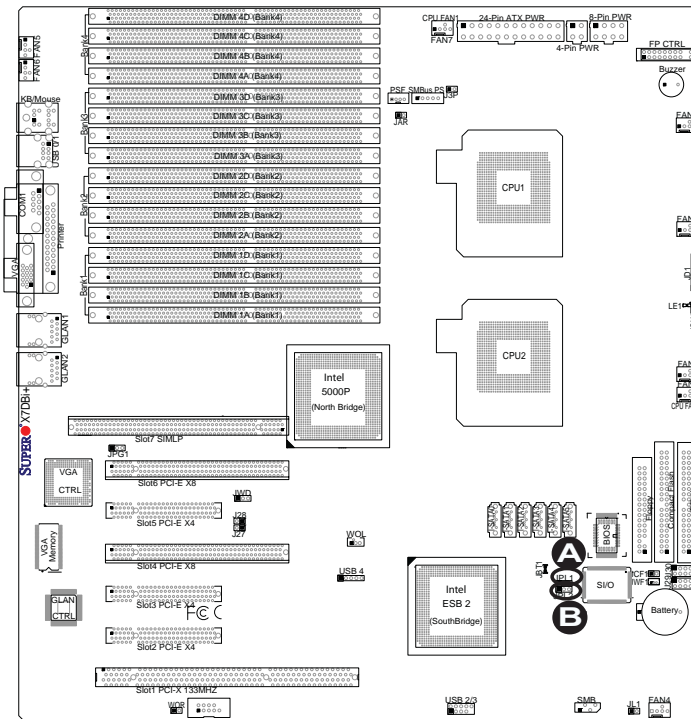

A. GLAN Port1 Enable

B. GLAN Port2 Enable

CMOS Clear

JBT1 is used to clear CMOS. Instead of pins, this "jumper" consists of contact pads to prevent the accidental clearing of CMOS. To clear CMOS, use a metal object such as a small screwdriver to touch both pads at the same time to short the connection. Always remove the AC power cord from the system before clearing CMOS. **Note:** For an ATX power supply, you must completely shut down the system, remove the AC power cord and then short JBT1 to clear CMOS.



Watch Dog Enable/Disable

Watch Dog is a system monitoring device that can reboot the system when a software application hangs. Close Pins 1-2 to reset the system if an application hangs. Close Pins 2-3 to generate a non-maskable interrupt signal for the application that hangs. See the table on the right for jumper settings. Watch Dog must also be enabled in BIOS.

Watch Dog Jumper Settings (JWD)	
Jumper Setting	Definition
Pins 1-2	Reset (*default)
Pins 2-3	NMI
Open	Disabled

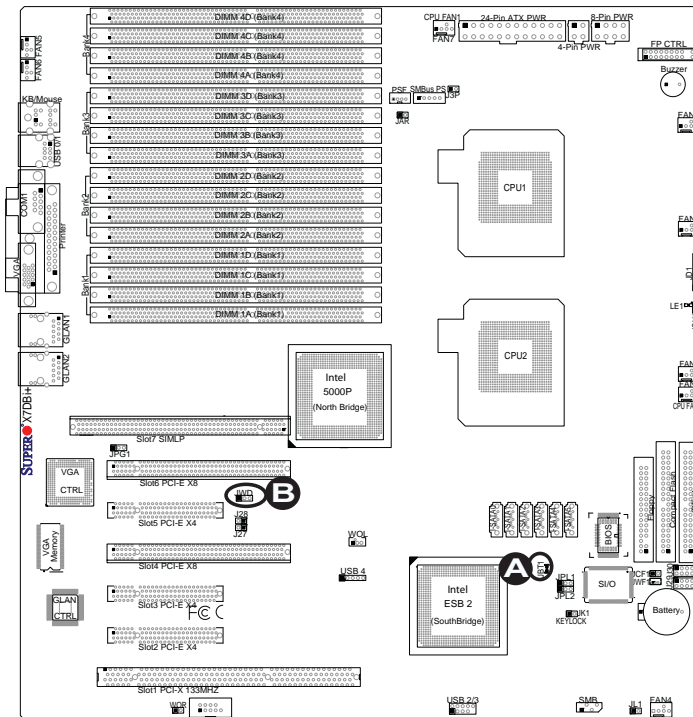

A. Clear CMOS

B. Watch Dog Enable

3rd PWR Supply PWR Fault Detect (J3P)

The system can notify you in the event of a power supply failure. This feature is available when three power supply units are installed in the chassis with one acting as a backup. If you only have one or two power supply units installed, you should disable this (the default setting) with J3P to prevent false alarms.

3rd PWR Supply PWR Fault Jumper Settings	
Jumper Setting	Definition
Closed	Enabled
Open	Disabled (*Default)

VGA Enable/Disable

JPG1 allows you to enable or disable the VGA port. The default position is on pins 1 and 2 to enable the VGA Connector. See the table on the right for jumper settings.

VGA Enable/Disable Jumper Settings (JPG1)	
Jumper Setting	Definition
Pins 1-2	Enabled
Pins 2-3	Disabled

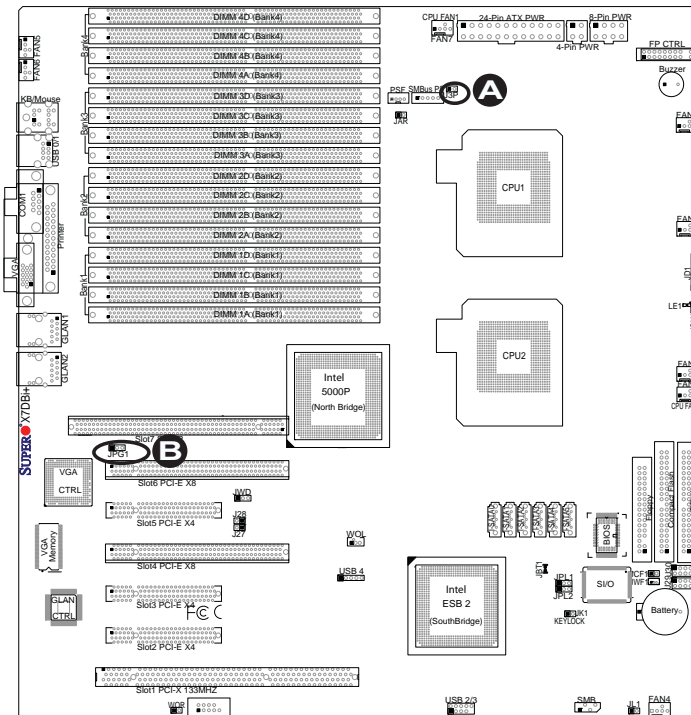

- A. 3rd PWR Fail
- B. VGA Enabled

Compact Flash Master/Slave Select

A Compact Flash Master (Primary)/Slave (Secondary) Select Jumper is located at JCF1. Close this jumper to enable Compact Flash Card. For the Compact Flash Card or the Compact Flash Jumper (JCF1) to work properly, please connect the Compact Flash Card power cable to JWF1 first. Refer to the board layout below for the location.

Compact Flash Card Master/ Slave Select	
Jumper	Definition
Open	Slave (Secondary)
Closed	Master (Primary)

I²C Bus to PCI-X/PCI-Exp. Slots

Jumpers J27 and J28 allow you to connect the System Management Bus (I²C) to the PCI-X/PCI-E slots. The default setting is "Open" to disable the connection. See the table on the right for jumper settings.

I ² C to PCI-S/PCI/Exp Jumper Settings	
Jumper Setting	Definition
Closed	Enabled
Open	Disabled (*Default)

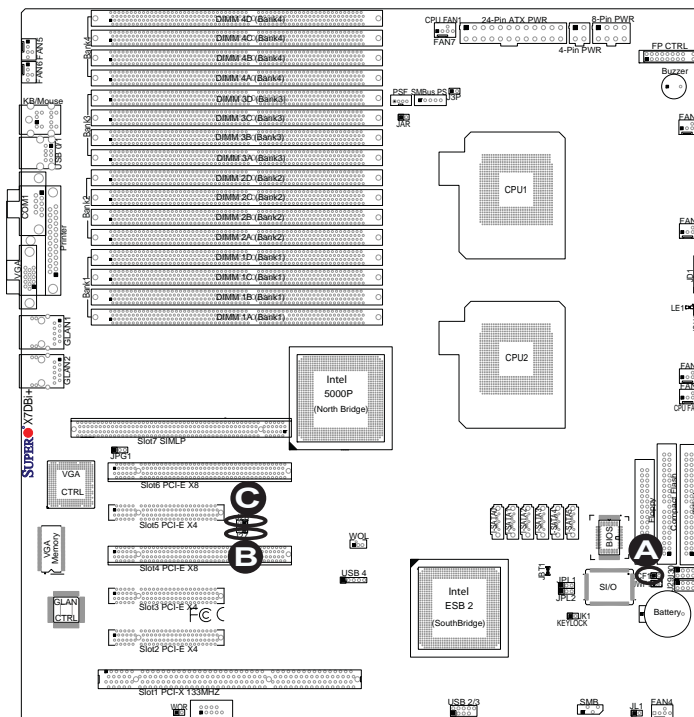

A. Compact Flash Master/ Slave Select

B. J27

C. J28

2-7 Onboard Indicators

GLAN LEDs

There are two GLAN ports on the motherboard. Each Gigabit Ethernet LAN port has two LEDs. The yellow LED indicates activity, while the Link LED may be green, amber or off to indicate the speed of the connection. See the tables at right for more information.

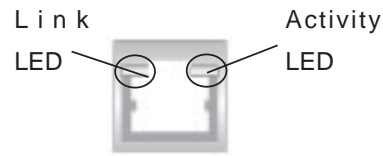

Rear View

GLAN Activity Indicator		
Color	Status	Definition
Yellow	Flashing	Active

GLAN Link Indicator	
LED Color	Definition
Off	No Connection or 10 Mbps
Green	100 Mbps
Amber	1 Gbps

Onboard Power LED

There is an Onboard Power LED located on the motherboard. When this LED is lit, the system is on. Be sure to turn off the system and unplug the power cord before removing or installing components. See the layout below for the LED location.

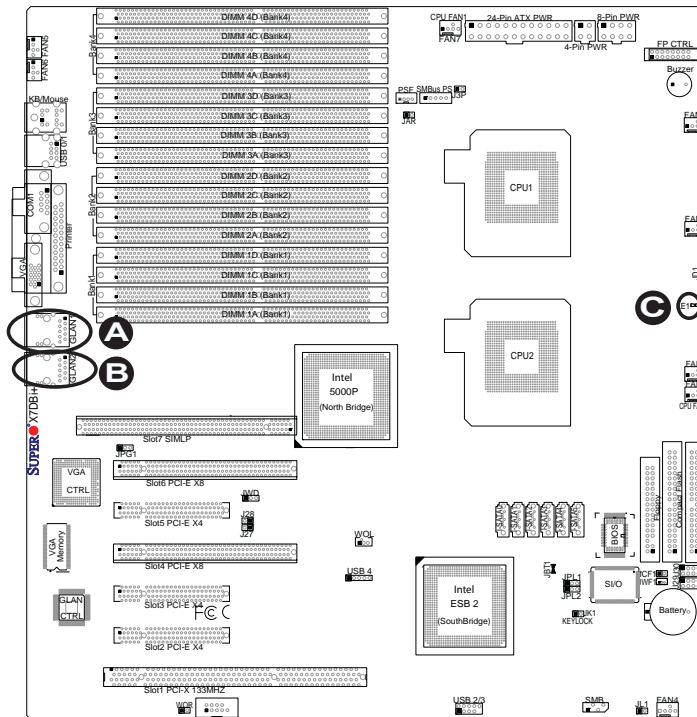

A. GLAN Port1 LEDs

B. GLAN Port2 LEDs

Overheat LED/Fan Fail (JOH1)

The JOH1 header is used to connect an LED to provide warnings of chassis overheating. This LED will blink to indicate a fan failure. Refer to the table on right for pin definitions.

Overheat LED Pin Definitions	
Pin#	Definition
1	5vDC
2	OH Active

OH/Fan Fail LED	
State	Message
Solid	Overheat
Blinking	Fan Fail

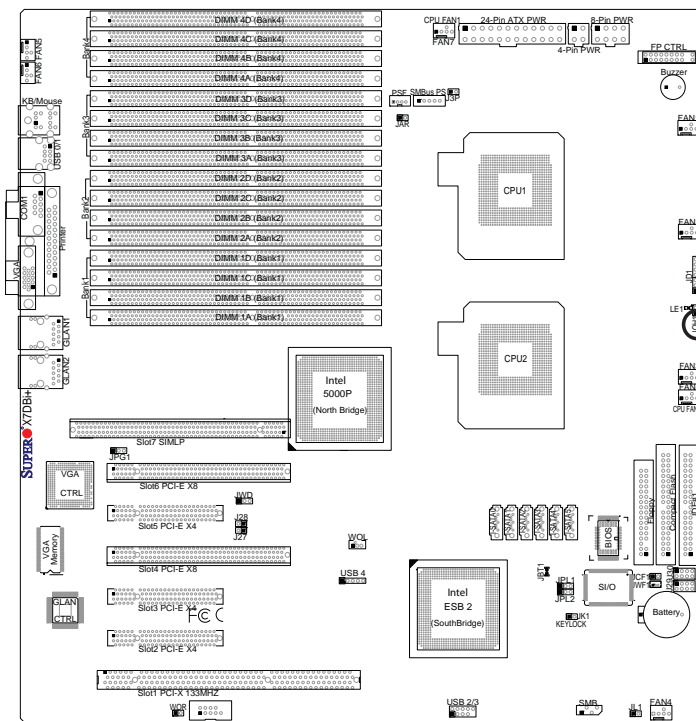

A. Overheat LED

2-8 Parallel Port, Floppy Drive, Hard Disk Drive and SIMLP Connections

Note the following when connecting the floppy and hard disk drive cables:

- The floppy disk drive cable has seven twisted wires.
- A red mark on a wire typically designates the location of pin 1.
- A single floppy disk drive ribbon cable has 34 wires and two connectors to provide for two floppy disk drives. The connector with twisted wires always connects to drive A, and the connector that does not have twisted wires always connects to drive B.

Parallel (Printer) Port Connector

The parallel (printer) port is located on the IO panel. See the table on the right for pin definitions.

Parallel (Printer) Port Connector Pin Definitions			
Pin#	Definition	Pin #	Definition
1	Strobe-	2	Auto Feed-
3	Data Bit 0	4	Error-
5	Data Bit 1	6	Init-
7	Data Bit 2	8	SLCT IN-
9	Data Bit 3	10	GND
11	Data Bit 4	12	GND
13	Data Bit 5	14	GND
15	Data Bit 6	16	GND
17	Data Bit 7	18	GND
19	ACK	20	GND
21	BUSY	22	Write Data
23	PE	24	Write Gate
25	SLCT	26	NC

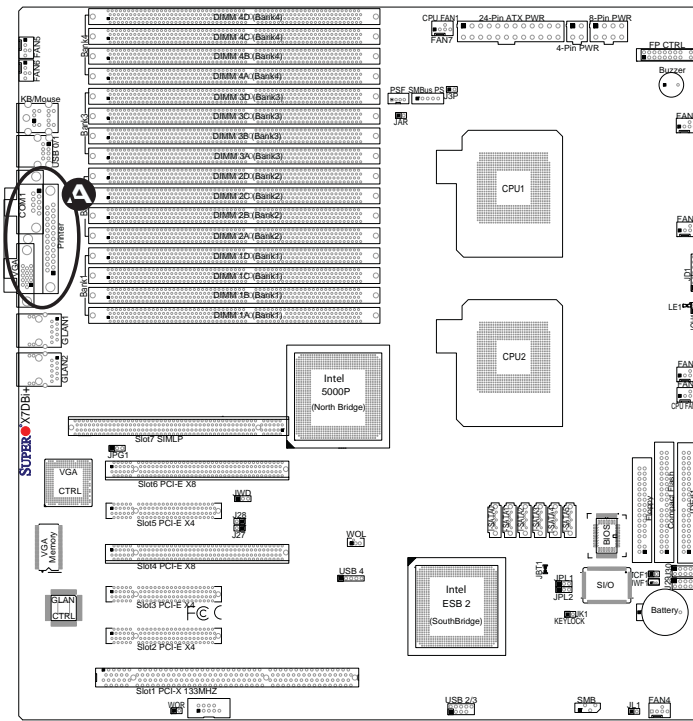

A. Parallel Port

Floppy Connector

The floppy connector is located next to the compact flash card slot. See the table below for pin definitions.

Floppy Drive Connector Pin Definitions (Floppy)			
Pin#	Definition	Pin #	Definition
1	Ground	2	FDHDIN
3	Ground	4	Reserved
5	Key	6	FDEDIN
7	Ground	8	Index
9	Ground	10	Motor Enable
11	Ground	12	Drive Select B
13	Ground	14	Drive Select B
15	Ground	16	Motor Enable
17	Ground	18	DIR
19	Ground	20	STEP
21	Ground	22	Write Data
23	Ground	24	Write Gate
25	Ground	26	Track 00
27	Ground	28	Write Protect
29	Ground	30	Read Data
31	Ground	32	Side 1 Select
33	Ground	34	Diskette

SIMLP Slot

There is a SIMLP (Supermicro Intelligent Management) add-on card slot (Slot 7) on the motherboard. Refer to the layout below for the IPMI Slot location.

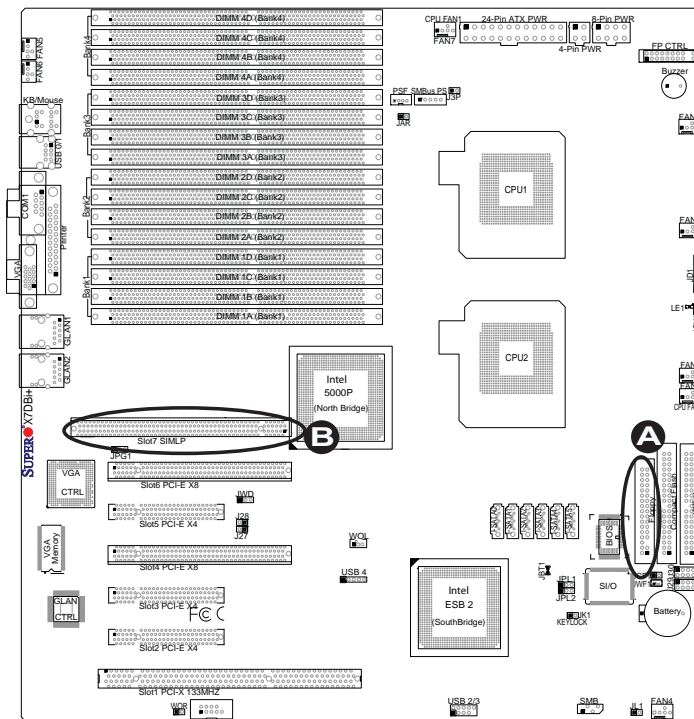

- A. Floppy
- B. SIMLP 2.0

IDE Connectors

There are two IDE Connectors (JIDE1: Blue, JIDE2: White) on the motherboard. The blue IDE connector (JIDE1) is designated the Primary IDE Drive. However, it also supports a compact flash card. The white IDE connector (JIDE2) is designated the Secondary IDE Drive, reserved for Compact Flash Card use only. (See the note below.) See the table on the right for pin definitions.

Note: JIDE2 (the white slot) is reserved for Compact Flash Card only. Do not use it for other devices. If JIDE2 is populated with a Compact Flash Card, JIDE1 (the blue slot) will be available for one device only. For the Compact Flash Card to work properly, you will need to enable its corresponding jumper, and connect a power cable to its corresponding power connector first.

IDE Drive Connectors Pin Definitions			
Pin#	Definition	Pin #	Definition
1	Reset IDE	2	Ground
3	Host Data 7	4	Host Data 8
5	Host Data 6	6	Host Data 9
7	Host Data 5	8	Host Data 10
9	Host Data 4	10	Host Data 11
11	Host Data 3	12	Host Data 12
13	Host Data 2	14	Host Data 13
15	Host Data 1	16	Host Data 14
17	Host Data 0	18	Host Data 15
19	Ground	20	Key
21	DRQ3	22	Ground
23	I/O Write	24	Ground
25	I/O Read	26	Ground
27	IOCHRDY	28	BALE
29	DACK3	30	Ground
31	IRQ14	32	IOCS16
33	Addr1	34	Ground
35	Addr0	36	Addr2
37	Chip Select 0	38	Chip Select 1
39	Activity	40	Ground

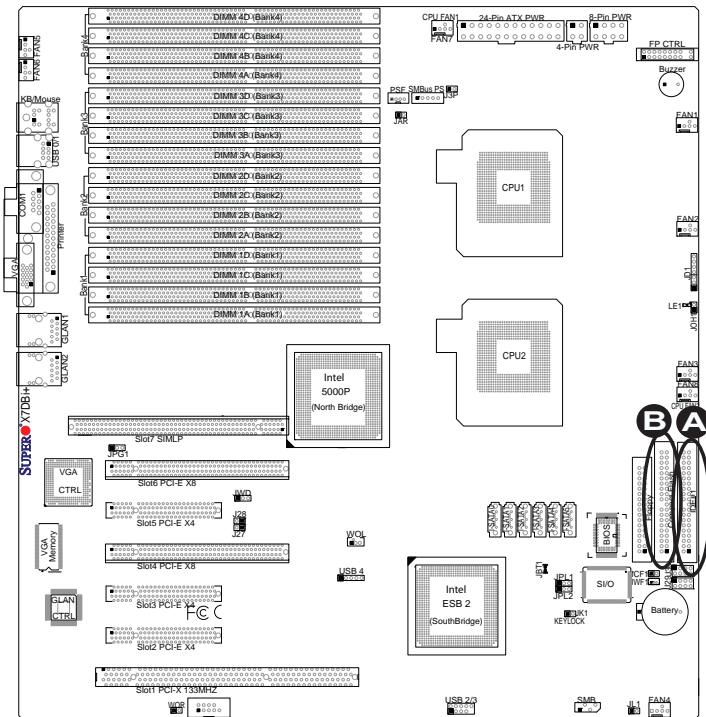

A. IDE1

B. Compact Flash Card

Slot

Chapter 3

Troubleshooting

3-1 Troubleshooting Procedures

Use the following procedures to troubleshoot your system. If you have followed all of the procedures below and still need assistance, refer to the 'Technical Support Procedures' and/or 'Returning Merchandise for Service' section(s) in this chapter.

Note: Always disconnect the power cord before adding, changing or installing any hardware components.

Before Power On

1. Make sure that there are no short circuits between the motherboard and chassis.
2. Disconnect all ribbon/wire cables from the motherboard, including those for the keyboard and mouse.
3. Remove all add-on cards.
4. Install one CPU (making sure it is fully seated) and connect the chassis speaker and the power LED to the motherboard. (Check all jumper settings as well.)

No Power

1. Make sure that no short circuits between the motherboard and the chassis.
2. Verify that all jumpers are set to their default positions.
3. Check that the 115V/230V switch on the power supply is properly set.
4. Turn the power switch on and off to test the system.
5. The battery on your motherboard may be old. Check to verify that it still supplies ~3VDC. If it does not, replace it with a new one.

No Video

1. If the power is on but you have no video, remove all the add-on cards and cables.
2. Use the speaker to determine if any beep codes exist. Refer to Appendix B for details on beep codes.

Losing the System's Setup Configuration

1. Make sure that you are using a high quality power supply. A poor quality power supply may cause the system to lose the CMOS setup information. Refer to Section 1-6 for details on recommended power supplies.
2. The battery on your motherboard may be old. Check to verify that it still supplies ~3VDC. If it does not, replace it with a new one.

3. If the above steps do not fix the Setup Configuration problem, contact your vendor for repairs.

NOTE

If you are a system integrator, VAR or OEM, a POST diagnostics card is recommended. For I/O port 80h codes, refer to App. B.

Memory Errors

1. Make sure that the DIMM modules are properly and fully installed.
2. Determine if different speeds of DIMMs have been installed and verify that the BIOS setup is configured for the fastest speed of RAM used. It is recommended to use the same RAM speed for all DIMMs in the system.
3. Make sure that you are using the correct type of DDR2 FBD (Fully Buffered) ECC 533/667 SDRAM (*recommended by the manufacturer.)
4. Check for bad DIMM modules or slots by swapping a single module between four slots and noting the results.
5. Make sure that all memory modules are fully seated in their slots. As an interleaved memory scheme is used, you must install four modules at a time, beginning with Branch 0, then Branch 1, and so on (see Page 2-6).
6. Check the position of the 115V/230V switch on the power supply.

3-2 Technical Support Procedures

Before contacting Technical Support, please take the following steps. Also, note that as a motherboard manufacturer, Supermicro does not sell directly to end-users, so it is best to first check with your distributor or reseller for troubleshooting services. They should know of any possible problem(s) with the specific system configuration that was sold to you.

1. Please go through the 'Troubleshooting Procedures' and 'Frequently Asked Question' (FAQ) sections in this chapter or see the FAQs on our web site (<http://www.supermicro.com/support/faqs/>) before contacting Technical Support.
2. BIOS upgrades can be downloaded from our web site at (<http://www.supermicro.com/support/bios/>).

Note: Not all BIOS can be flashed; it depends on the modifications to the boot block code.

3. If you still cannot resolve the problem, include the following information when contacting Supermicro for technical support:

- Motherboard model and PCB revision number
- BIOS release date/version (this can be seen on the initial display when your

system first boots up)

- System configuration

An example of a Technical Support form is on our web site at

<http://www.supermicro.com/support/contact.cfm>.

4. Distributors: For immediate assistance, please have your account number ready when placing a call to our technical support department. We can be reached by e-mail at support@supermicro.com or by fax at: (408) 503-8000, option 2.

3-3 Frequently Asked Questions

Question: What are the various types of memory that my motherboard can support?

Answer: The X7DBi+ has sixteen 240-pin DIMM slots that support DDR2 FBD ECC 533/667 SDRAM modules. It is strongly recommended that you do not mix memory modules of different speeds and sizes.

Question: How do I update my BIOS?

It is recommended that you **do not** upgrade your BIOS if you are not experiencing any problems with your system. Updated BIOS files are located on our web site at <http://www.supermicro.com/support/bios/>. Please check our BIOS warning message and the information on how to update your BIOS on our web site. Select your motherboard model and download the BIOS file to your computer. Also, check the current BIOS revision and make sure that it is newer than your BIOS before downloading. You can choose from the zip file and the .exe file. If you choose the zip BIOS file, please unzip the BIOS file onto a bootable USB device. Run the batch file using the format flash.bat filename.rom from your bootable USB device to flash the BIOS. Then, your system will automatically reboot. If you choose the .exe file, please run the .exe file under Windows to create the BIOS flash floppy disk. Insert the floppy disk into the system you wish to flash the BIOS. Then, bootup the system to the floppy disk. The BIOS utility will automatically flash the BIOS without any prompts. Please note that this process may take a few minutes to complete. Do not be concerned if the screen is paused for a few minutes.



(Warning: Do not shut down or reset the system while updating BIOS to prevent possible system boot failure!)

Question: What's on the CD that came with my motherboard?

Answer: The supplied compact disc has quite a few drivers and programs that will greatly enhance your system. We recommend that you review the CD and install the applications you need. Applications on the CD include chipset drivers for Windows and security and audio drivers.

3-4 Returning Merchandise for Service

A receipt or copy of your invoice marked with the date of purchase is required before any warranty service will be rendered. You can obtain service by calling your vendor for a Returned Merchandise Authorization (RMA) number. For faster service, You can also request a RMA authorization online (<http://www.supermicro.com/support/rma/>). When returning to the manufacturer, the RMA number should be prominently displayed on the outside of the shipping carton, and mailed prepaid or hand-carried. Shipping and handling charges will be applied for all orders that must be mailed when service is complete.

This warranty only covers normal consumer use and does not cover damages incurred in shipping or from failure due to the alternation, misuse, abuse or improper maintenance of products.

During the warranty period, contact your distributor first for any product problems.

Chapter 4

BIOS

4-1 Introduction

This chapter describes the Phoenix BIOS™ Setup utility for the X7DBi+. The Phoenix ROM BIOS is stored in a flash chip and can be easily upgraded using a floppy disk-based program.

Note: Due to periodic changes to the BIOS, some settings may have been added or deleted and might not yet be recorded in this manual. Please refer to the Manual Download area of the Supermicro web site <<http://www.supermicro.com>> for any changes to the BIOS that may not be reflected in this manual.

System BIOS

The BIOS is the Basic Input Output System used in all IBM® PC, XT™, AT®, and PS/2® compatible computers. The Phoenix BIOS stores the system parameters, types of disk drives, video displays, etc. in the CMOS. The CMOS memory requires very little electrical power. When the computer is turned off, a backup battery provides power to the CMOS logic, enabling it to retain system parameters. When a computer is powered on, the computer is configured with the values stored in the CMOS logic by the system BIOS, which gains control at boot up.

How To Change the Configuration Data

The CMOS information that determines the system parameters may be changed by entering the BIOS Setup utility. This Setup utility can be accessed by pressing the <Delete> key at the appropriate time during system boot.

Starting the Setup Utility

Normally, the only visible POST (Power On Self Test) routine is the memory test. As the memory is being tested, press the <Delete> key to enter the main menu of the BIOS Setup utility. From the main menu, you can access the other setup screens, such as the Security and Power menus. Beginning with Section 4-3, detailed descriptions are given for each parameter setting in the Setup utility.



Warning: Do not shut down or reset the system while updating BIOS to prevent possible boot failure.

4-2 Running Setup

**Default settings are in bold text unless otherwise noted.*

The BIOS setup options described in this section are selected by choosing the appropriate text from the main BIOS Setup screen. All displayed text is described in this section, although the screen display is often all you need to understand how to set the options (see the next page).

When you first power on the computer, the Phoenix BIOS™ is immediately activated.

While the BIOS is in control, the Setup program can be activated in one of two ways:

1. By pressing <Delete> immediately after turning the system on, or
2. When the message shown below appears briefly at the bottom of the screen during the POST (Power On Self-Test), press the <Delete> key to activate the main Setup menu:

Press the <Delete> key to enter Setup

4-3 Main BIOS Setup

All main Setup options are described in this section. The main BIOS Setup screen is displayed below.

Use the Up/Down arrow keys to move between the different settings in each menu. Use the Left/Right arrow keys to change the options for each setting.

Press the <Esc> key to exit the CMOS Setup Menu. The next section describes in detail how to navigate through the menus.

Items that use submenus are indicated with the ► icon. With the item highlighted, press the <Enter> key to access the submenu.

Main BIOS Setup Menu

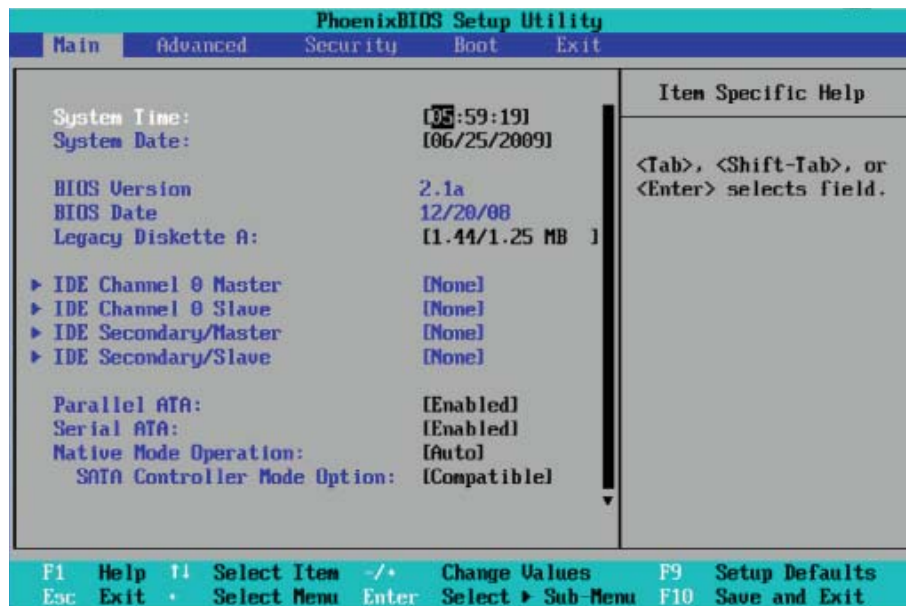

Main Setup Features

System Time

To set the system date and time, key in the correct information in the appropriate fields. Then press the <Enter> key to save the data.

System Date

Using the arrow keys, highlight the month, day and year fields, and enter the correct data. Press the <Enter> key to save the data.

BIOS Version

This field displays the version of the current BIOS.

BIOS Date

The item displays the date that the BIOS was built.

Legacy Diskette A

This setting allows the user to set the type of floppy disk drive installed as diskette A. The options are Disabled, 360Kb 5.25 in, 1.2MB 5.25 in, 720Kb 3.5 in, **1.44/1.25MB**, 3.5 in and 2.88MB 3.5 in.

► IDE Channel 0 Master/Slave and IDE Secondary Master/Slave

These settings allow the user to set the parameters of the slots specified. Press <Enter> to activate the following submenu items for detailed options. Set the correct configurations accordingly.

Type

This item allows you to select the type of IDE hard drive. Select **Auto** to allow the BIOS to automatically set the HDD's capacity, number of heads, etc. Enter a number from 1-39 to select a type of hard drive. Select User to allow the user to enter the parameters of the HDD installed at this connection. Select CDROM if a CDROM drive is installed. Select ATAPI if a removable disk drive is installed.

Multi-Sector Transfers

This item allows the user to specify the number of sectors per block to be used in multi-sector transfer. The options are **Disabled**, 4 Sectors, 8 Sectors, and 16 Sectors.

LBA Mode Control

This item determines whether the Phoenix BIOS will access the IDE Channel 0 Master Device via the LBA mode. The options are Enabled and **Disabled**.

32 Bit I/O

This option allows the user to enable or disable the function of 32-bit data transfer. The options are Enabled and **Disabled**.

Transfer Mode

This option allows the user to set the transfer mode. The options are **Standard**, Fast PIO1, Fast PIO2, Fast PIO3, Fast PIO4, FPIO3/DMA1 and FPIO4/DMA2.

Ultra DMA Mode

This option allows the user to select Ultra DMA Mode. The options are **Disabled**, Mode 0, Mode 1, Mode 2, Mode 3, Mode 4, and Mode 5.

Parallel ATA

This setting allows the user to enable or disable the function of Parallel ATA. The options are Disabled, and **Enabled**.

Serial ATA

This setting allows the user to enable or disable the function of Serial ATA. The options are Disabled and **Enabled**.

Native Mode Operation (Available when SATA Controller Mode below is set to Compatible)

Select the native mode for ATA. The options are: Serial ATA, and **Auto**.

SATA Controller Mode

Select **Compatible** to allow the SATA and PATA drives to be automatically-detected and be placed in the Legacy Mode by the BIOS. Select **Enhanced** to allow the SATA and PATA drives to be automatically-detected and be placed in the Native IDE Mode. (**Note: The Enhanced mode is supported by the Windows 2000 OS or a later version.**)

When the SATA Controller Mode is set to "Enhanced", the following items will display:

Serial ATA (SATA) RAID Enable

Select **Enable** to enable Serial ATA RAID Functions. (If this feature is set to **Enabled**, be sure to use the RAID driver for the Windows OS. When this item is set to **Enabled**, the item: "ICH RAID Code Base" will be available for you to select either Intel or Adaptec Host RAID firmware for your RAID settings. If this item is set to **Disabled**, the item-SATA AHCI Enable will be available.) The options are **Enabled** and **Disabled**.

ICH RAID Code Base (Available when SATA RAID is enabled.)

Select **Intel** to enable Intel's SATA RAID firmware. Select **Adaptec** to use Adaptec's HostRAID firmware. The options are **Intel** and **Adaptec**.

SATA AHCI (Available when SATA RAID is disabled.)

Select **Enable** to enable the function of Serial ATA Advanced Host Interface. (Take caution when using this function. This feature is for advanced programmers only. The options are **Enabled** and **Disabled**.)

System Memory

This display informs you how much system memory is detected by the BIOS.

Extended Memory

This display informs you how much extended memory is detected by the BIOS.

4-4 Advanced Setup

Choose Advanced from the Phoenix BIOS Setup Utility main menu with the arrow keys. You should see the following display. The items with a triangle beside them have sub menus that can be accessed by highlighting the item and pressing <Enter>.

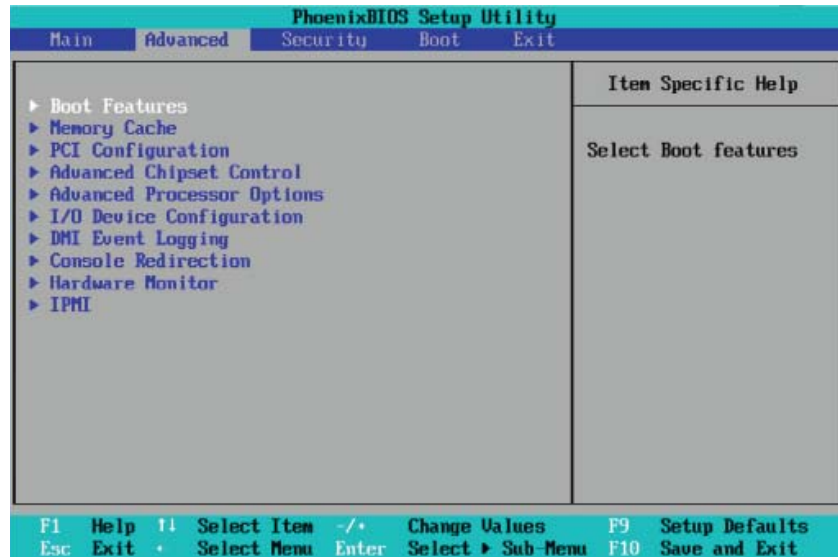

▶ Boot Features

Access the submenu to make changes to the following settings.

QuickBoot Mode

If enabled, this feature will speed up the POST (Power On Self Test) routines by skipping certain tests after the computer is turned on. If Disabled, the POST routine will run at normal speed. The options are **Enabled** and Disabled.

QuietBoot Mode

This setting allows you to **Enable** or Disable the graphic logo screen during boot-up. The options are **Enabled** and Disabled.

POST Errors

Select **Enabled** to temporarily halt system boot and display POST (Power-On-Self Testing) error messages when errors occur during bootup. Select Disable to continue with system boot even when an error occurs. The options are **Enabled** and Disabled.

ACPI Mode

Use the setting to determine if you want to employ ACPI (Advanced Configuration and Power Interface) power management on your system. The options are **Yes** and No.

Power Button Behavior

If set to **Instant-Off**, the system will power off immediately as soon as the user

hits the power button. If set to 4-sec., the system will power off when the user presses the power button for 4 seconds or longer. The options are **Instant-off** and 4-sec override.

Resume On Modem Ring

Select On to “wake your system up” when an incoming call is received by your modem. The options are On and **Off**.

Power Loss Control

This setting allows you to choose how the system will react when power returns after an unexpected loss of power. The options are Stay Off, Power On, and **Last State**.

Watch Dog

If enabled, this option will automatically reset the system if the system is not active for more than 5 minutes. The options are Enabled and **Disabled**.

Summary Screen

This setting allows you to **Enable** or Disable the summary screen which displays the system configuration information at bootup.

► Memory Cache

Cache System BIOS Area

This setting allows you to designate a reserve area in the system memory to be used as a System BIOS buffer to allow the BIOS to write (cache) data into this reserved memory area. Select **Write Protect** to enable this function, and this area will be reserved for BIOS ROM access only. Select "Uncached" to disable this function and make this area available for other devices.

Cache Video BIOS Area

This setting allows you to designate a reserve area in the system memory to be used as a Video BIOS buffer to allow the BIOS to write (cache) data into this reserved memory area. Select **Write Protect** to enable the function and this area will be reserved for Video BIOS ROM access only. Select Uncached to disable this function and make this area available for other devices.

Cache Base 0-512K

If enabled, this feature will allow the data stored in the base memory area: block 0-512K to be cached (written) into a buffer, a storage area in the Static DROM (SDROM) or to be written into L1, L2 cache inside the CPU to speed up CPU operations. Select Uncached to disable this function. Select Write Through to allow data to be cached into the buffer and written into the system memory at the same time. Select Write Protect to prevent data from being written into the base

memory area of Block 0-512K. Select Write Back to allow the CPU to write data back directly from the buffer without writing data to the System Memory for fast CPU data processing and operation. The options are Uncached, Write Through, Write Protect, and **Write Back**.

Cache Base 512K-640K

If enabled, this feature will allow the data stored in the memory area: 512K-640K to be cached (written) into a buffer, a storage area in the Static DRAM (SDRAM) or written into L1, L2, L3 cache inside the CPU to speed up CPU operations. Select Uncached to disable this function. Select Write Through to allow data to be cached into the buffer and written into the system memory at the same time. Select Write Protect to prevent data from being written into the base memory area of Block 512-640K. Select Write Back to allow the CPU to write data back directly from the buffer without writing data to the System Memory for fast CPU data processing and operation. The options are Uncached, Write Through, Write Protect, and **Write Back**.

Cache Extended Memory

If enabled, this feature will allow the data stored in the extended memory area to be cached (written) into a buffer, a storage area in the Static DRAM (SDRAM) or written into L1, L2, L3 cache inside the CPU to speed up CPU operations. Select Uncached to disable this function. Select Write Through to allow data to be cached into the buffer and written into the system memory at the same time. Select Write Protect to prevent data from being written into the extended memory area above 1 MB. Select Write Back to allow the CPU to write data back directly from the buffer without writing data to the System Memory for fast CPU data processing and operation. The options are Uncached, Write Through, Write Protect, and **Write Back**.

Discrete MTRR Allocation

If enabled, MTRRs (-Memory Type Range Registers) are configured as distinct, separate units and cannot be overlapped. If enabled, the user can achieve better graphic effects when using a Linux graphic driver that requires the write-combining configuration with 4GB or more memory. The options are Enabled and **Disabled**.

► PCI Configuration

Access the submenu to make changes to the following settings for PCI devices.

Onboard GLAN1/Onboard GLAN2 (Gigabit- LAN) OPROM Configure

Enabling this option provides the capability to boot from the GLAN ports as specified. The options are **Disabled** and Enabled.

IPMI 3rd_LAN OPROM Configure

Select Enabled to allow the system to boot from IPMI_Dedicated_LAN. The options are **Disabled** and Enabled.

Default Primary Video Adapter

This feature allows the user to specify which video adapter to be used as the default primary video adapter--the onboard video adapter or others. The options are Other and **Onboard Video**.

Emulated IRQ Solutions

When Enabled, the Emulated IRQ Scheme will allow PCI devices to run on legacy operating systems that use the MSI mechanism to generate INTX compatible interrupts. The options are **Disabled** and Enabled.

PCI-Exp. I/O Performance

Some add-on cards perform faster with the coalesce feature, which limits the payload size to 128 Bytes; while others perform better with a payload size of 256 Bytes, which inhibits the coalesce feature. Please refer to your add-on card user guide for the desired setting. The options are Payload (256 Bytes) and **Coalesce Enabled (128 Bytes)**.

PCI Parity Error Forwarding

The feature allows SERR and PERR errors detected in the PCI slots to be sent (forwarded) to the BIOS DMI Event Log for the user to review. The options are Enabled and Disabled.

ROM Scan Ordering

This feature allows the user to decide which Option ROM to be activated first. The options are **Onboard first** and Add-On first.

Reset Configuration Data

If set to Yes, this setting clears the Extended System Configuration Data- (ESCD) area. The options are Yes and **No**.

Frequency for PCI-X#1

This option allows the user to change the bus frequency for the devices installed in the slot indicated. The options are **Auto**, PCI 33 MHz, PCI 66 MHz, PCI-X 66 MHz, PCI-X 100 MHz, and PCI-X 133 MHz.

► Slot#1 PCI-X133 MHz, Slot#2 PCI-Exp. x4, Slot#3 PCI-Exp. x4, Slot#4 PCI-E x8, Slot#5 PCI-Exp. x4 and Slot#6 PCI-Exp. x8

Access the submenu for each of the settings above to make changes to the following:

Option ROM Scan

When enabled, this setting will initialize the device expansion ROM. The options are **Enabled** and Disabled.

Enable Master

This setting allows you to enable the selected device as the PCI bus master. The options are **Enabled** and Disabled.

Latency Timer

This setting allows you to set the clock rate for Bus Master. A high-priority, high-throughput device may benefit from a greater clock rate. The options are **Default**, 0020h, 0040h, 0060h, 0080h, 00A0h, 00C0h, and 00E0h. For Unix, Novell and other Operating Systems, please select the option: other. If a drive fails after the installation of a new software, you might want to change this setting and try again. A different OS requires a different Bus Master clock rate.

Large Disk Access Mode

This setting determines the size of a hard drive to be accessed by the user. The options are **DOS** or Other (for Unix, Novelle NetWare and other operating systems).

► Advanced Chipset Control

Access the submenu to make changes to the following settings.

 **Warning:** Take Caution when changing the Advanced settings. Incorrect values entered may cause the system to malfunction. Also, a very high DRAM frequency or incorrect DRAM timing may cause system instability. When this occurs, revert the setting to the default setting.

SERR Signal Condition

This setting specifies the ECC Error conditions that an SERR# is to be asserted. The options are None, **Single Bit**, Multiple Bit, and Both.

4GB PCI Hole Granularity

This feature allows you to select the granularity of PCI holes for the PCI slots. If MTRRs are not enough, this option may be used to reduce MTRR occupation. The options are: **256 MB**, 512 MB, 1GB and 2GB.

Memory Branch Mode

This option determines how the two memory branches operate. System address space can either be interleaved between the two branches or Sequential from one branch to another. Mirror mode allows data correction by maintaining two copies of data in two branches. Single Channel 0 allows a single DIMM population during system manufacturing. The options are **Interleave**, Sequential, Mirroring, and Single Channel 0.

Branch 0 Rank Sparing/Branch 1 Rank Sparing

Select **Enabled** to enable the function of memory sparing for Memory Bus Branch 0 or Branch 1 to enhance memory performance. The options are Enabled and **Disabled**.

Branch 0 Rank Interleaving/Branch 1 Rank Interleaving

Select enable to enable Interleaved Memory for Memory Bus Branch 0 Rank or Branch 1 Rank to increase data security. The options for Memory Interleaving are 1:1, 2:1 and **4:1**.

Enhanced x8 Detection

Select **Enabled** to enable Enhanced x8 DRAM UC Error Detection. The options are Disabled and **Enabled**.

High Bandwidth FSB

Select Enabled to enable high bandwidth Front Side Bus (FSB). The options are **Enabled** and Disabled.

High Temperature DRAM Operation

When set to Enabled, the BIOS will refer to the SPD table to set the maximum DRAM temperature. If disabled, the BIOS will set the maximum DRAM temperature based on a predefined value. The options are Enabled and **Disabled**.

AMB Thermal Sensor

Select Enabled to enable the thermal sensor embedded in the Advanced Memory Buffer on a fully buffered memory module for thermal monitoring. The options are **Disabled** and Enabled.

Thermal Throttle

Select Enabled to enable closed-loop thermal throttling on a fully buffered (FBD) memory module. In the closed-loop thermal environment, thermal throttling will be activated when the temperature of the FBD DIMM module exceeds a predefined threshold. The options are Enabled and **Disabled**.

Global Activation Throttle

Select Enabled to enable the function of open-loop global thermal throttling on the fully buffered (FBD) memory modules and allow global thermal throttling to become active when the number of activate control exceeds a predefined number. The options are Enabled and **Disabled**.

Crystal Beach Features

Select **Enabled** to use the Intel I/O AT (Acceleration Technology) to accelerate the performance of TOE devices. (**Note:** A TOE device is a specialized, dedicated processor that is installed on an add-on card or a network card to handle some or all packet processing of this add-on card. For this motherboard, the TOE device is built inside the ESB 2 South Bridge chip.) The options are **Enabled** and Disabled.

Route Port 80h Cycles to

This feature allows the user to decide which bus to send debug information to. The options are Disabled, PCI and **LPC**.

Clock Spectrum Feature

If Enabled, the BIOS will monitor the level of Electromagnetic Interference caused by the components and will attempt to decrease the interference whenever needed. The options are Enabled and **Disabled**.

High Precision Event Time

Select Yes to activate the High Precision Event Timer (HPET), which is capable of producing periodic interrupts at a much higher frequency than a Real-time Clock (RTC) can in synchronizing multimedia streams, providing smooth playback and reducing the dependency on other timestamp calculation devices, such as an x86

RDTSC Instruction embedded in a CPU. The High Precision Event Timer is used to replace the 8254 Programmable Interval Timer. The default setting is **No**.

USB Function

Select Enabled to enable the function of USB devices specified. The settings are **Enabled** and Disabled.

Legacy USB Support

This setting allows you to enable support for Legacy USB devices. The settings are **Enabled** and Disabled.

► Advanced Processor Options

Access the submenu to make changes to the following settings.

CPU Speed

This is a display that indicates the speed of the installed processor.

Frequency Ratio (Available when supported by the CPU.)

The feature allows the user to set the internal frequency multiplier for the CPU. The options are: **Default**, x6, and x7. (**Note:** The settings can be different, depending on the CPU speed.)

Core-Multi-Processing (Available when supported by the CPU.)

Set to **Enabled** to use a processor's Second Core and beyond. (Please refer to Intel's web site for more information.) The options are **Disabled** and **Enabled**.

Machine Checking (Available when supported by the CPU.)

Set to **Enabled** to activate the function of Machine Checking and allow the CPU to detect and report hardware (machine) errors via a set of model-specific registers (MSRs). The options are **Disabled** and **Enabled**.

Thermal Management 2 (Available when supported by the CPU.)

Set to **Enabled** to use Thermal Management 2 (TM2) which will lower CPU voltage and frequency when the CPU temperature reaches a predefined overheat threshold. Set to **Disabled** to use Thermal Manager 1 (TM1), allowing CPU clocking to be regulated via CPU Internal Clock modulation when the CPU temperature reaches the overheat threshold. The options are **Disabled** and **Enabled**.

C1 Enhanced Mode (Available when supported by the CPU.)

Set to **Enabled** to enable Enhanced Halt State to lower CPU voltage/frequency to prevent overheat. The options are **Enabled** and **Disabled**. (**Note:** please refer to Intel's web site for detailed information.)

Execute Disable Bit (Available when supported by the CPU and the OS.)

Set to **Enabled** to enable Execute Disable Bit and allow the processor to classify areas in memory where an application code can execute and where it cannot, and thus preventing a worm or a virus from inserting or creating a flood of codes to overwhelm the processor or damage the system during an attack. (**Note:** this feature is available when your OS and your CPU support the function of Execute Disable Bit.) The options are **Disabled** and **Enabled**. (**Note:** For more information regarding hardware/software support for this function, please refer to Intel's and Microsoft's web sites.)

Adjacent Cache Line Prefetch (Available when supported by the CPU.)

The CPU fetches the cache line for 64 bytes if this option is set to Disabled. The CPU fetches both cache lines for 128 bytes as comprised if Enabled. The options are **Disabled** and Enabled.

Hardware Prefetch (Available when supported by the CPU.)

Set to this option to **enabled** to enable the hardware components that are used in conjunction with software programs to prefetch data in order to shorten execution cycles and maximize data processing efficiency. The options are Disabled and **Enabled**.

Direct Cache Access (Available when supported by the CPU.)

Set to Enable to route inbound network IO traffic directly into processor caches to reduce memory latency and improve network performance. The options are **Disabled** and Enabled. If this item is set to Enabled, the following item will display.

DCA Delay Clocks (Available when supported by the CPU.)

This feature allows the user to set the clock delay setting from snoop to prefetch for Direct Cache Access. Select a setting from 8 (bus cycles) to 120 (bus cycles) (in 8-cycle increment). The default setting is **32 (bus cycles)**.

Intel <R> Virtualization Technology (Available when supported by the CPU.)

Select Enabled to use the feature of Virtualization Technology to allow one platform to run multiple operating systems and applications in independent partitions, creating multiple "virtual" systems in one physical computer. The options are Enabled and **Disabled**. (Note: If there is any change to this setting, you will need to power off and restart the system for the change to take effect.) Please refer to Intel's web site for detailed information.

Intel EIST Support (Available when supported by the CPU.)

Select Enabled to use the Enhanced Intel SpeedStep Technology and allows the system to automatically adjust processor voltage and core frequency in an effort to reduce power consumption and heat dissipation. The options are Enabled (C States & GV1/GV3 are enabled), GV1/GV3 (GV1/GV3 are enabled, but C States are disabled.), C States Only (GV1/GV3 are disabled, but C States are enabled.), and **Disabled (C States & GV1/GV3 are disabled)**. Please refer to Intel's web site for detailed information.

► I/O Device Configuration

Access the submenu to make changes to the following settings.

KBC Clock Input

This setting allows you to select clock frequency for the keyboard controller. The options are 6MHz, 8MHz, **12MHz**, and 16MHz.

Serial Port A

This setting allows you to determine how Serial Port A is managed by the system. The options are **Enabled** (user defined), Disabled, and Auto (BIOS- or OS-controlled).

Base I/O Address

This setting allows you to select the base I/O address for Serial Port A. The options are **3F8**, 2F8, 3E8, and 2E8.

Interrupt

This setting allows you to select the IRQ (interrupt request) for Serial Port A. The options are IRQ3 and **IRQ4**.

Serial Port B (*Not for external use, used for IPMI only)

This setting allows you to determine how Serial Port B is managed by the system. The options are **Enabled** (user defined), Disabled, Auto (BIOS controlled) and OS Controlled.

Mode

This setting allows you to set the type of device that will be connected to Serial Port B. The options are **Normal** and IR (for an infrared device).

Base I/O Address

This setting allows you to select the base I/O address for Serial Port B. The options are 3F8, **2F8**, 3E8 and 2E8.

Interrupt

This setting allows you to select the IRQ (interrupt request) for Serial Port B. The options are **IRQ3** and IRQ4.

Parallel Port

This setting allows you to determine how your parallel port is managed by the system. The options are **Enabled** (user defined), Disabled and Auto (BIOS- or OS-controlled).

Base I/O Address

Select the base I/O address for the parallel port. The options are **378**, 278 and 3BC.

Interrupt

This setting allows you to select the IRQ (interrupt request) for the parallel port. The options are IRQ5 and **IRQ7**.

Mode

This feature allows you to specify the parallel port mode. The options are Output only, Bi-Directional, EPP and **ECP**.

DMA Channel

This item allows you to specify the DMA channel for the parallel port. The options are DMA1 and **DMA3**.

Floppy Disk Controller

This setting allows you to assign control of the floppy disk controller. The options are **Enabled** (user defined), Disabled, and Auto (BIOS and OS controlled).

Base I/O Address

This setting allows you to select the base I/O address for the parallel port. The options are **Primary** and Secondary.

► DMI Event Logging

Access the submenu to make changes to the following settings.

Event Log Validity

This is a display to inform you of the event log validity. It is not a setting.

Event Log Capacity

This is a display to inform you of the event log capacity. It is not a setting.

View DMI Event Log

Highlight this item and press <Enter> to view the contents of the event log.

Event Logging

This setting allows you to **Enable** or Disable event logging.

ECC Event Logging

This setting allows you to **Enable** or Disable ECC event logging.

Mark DMI Events as Read

Highlight this item and press <Enter> to mark the DMI events as read.

Clear All DMI Event Logs

Select Yes and press <Enter> to clear all DMI event logs. The options are Yes and **No**.

► Console Redirection

Access the submenu to make changes to the following settings.

COM Port Address

This item allows you to specify which COM port to direct the remote console to: Onboard COM A or Onboard COM B. This setting can also be **Disabled**.

BAUD Rate

This item allows you to set the BAUD rate for Console Redirection. The options are 300, 1200, 2400, 9600, **19.2K**, 38.4K, 57.6K, and 115.2K.

Console Type

This item allows you to choose the console redirection type. The options are VT100, VT100,8bit, PC-ANSI, 7bit, **PC ANSI**, VT100+, and VT-UTF8.

Flow Control

This item allows you to set the flow control for the console redirection. The options are: None, XON/XOFF, and **CTS/RTS**.

Console Connection

This item allows you to decide how the console redirection is to be connected: either **Direct** or Via Modem.

Continue CR after POST

This item allows you to decide whether you want to continue with console redirection after POST routines. The options are On and **Off**.

► Hardware Monitoring

This feature allows the user to monitor system health and review the status of each item as displayed.

CPU Overheat Alarm

This option allows the user to select the CPU Overheat Alarm setting which determines when the CPU OH alarm will be activated to provide warning of possible CPU overheat.



Warning! 1. Any temperature that exceeds the CPU threshold temperature predefined by the CPU manufacturer may result in CPU overheat or system instability. When the CPU temperature reaches this predefined threshold, the CPU and system cooling fans will run at full speed.

2. To avoid possible system overheating, please be sure to provide adequate airflow to your system.

The options are:

- **Early Alarm:** Select this setting if you want the CPU overheat alarm (including the LED and the buzzer) to be triggered as soon as the CPU temperature reaches the CPU overheat threshold as predefined by the CPU manufacturer.
- **Default Alarm:** Select this setting if you want the CPU overheat alarm (including the LED and the buzzer) to be triggered when the CPU temperature reaches about 5°C above the threshold temperature as predefined by the CPU manufacturer to give the CPU and system fans additional time needed for CPU and system cooling. In both the alarms above, please take immediate action as shown below.

PECI Agent 1/2 (Temperatures)/System Temperature

Note: The following item display temperature readings for the PECI Agents and the system. These items are displayed for your reference only.

Low – This level is considered as the ‘normal’ operating state. The PECI Agent temperature is well below its ‘Temperature Tolerance’. The cooling fans and PECI Agent will run normally as configured in the BIOS (Fan Speed Control). User

Medium – The PECI Agent is running warmer. This is a ‘precautionary’ level and generally means that there may be factors contributing to this condition, but the PECI Agent is still within its normal operating state and below its ‘Temperature Tolerance’. The cooling fans will run normally as configured in the BIOS. The fans may adjust to a faster speed depending on the Fan Speed Control settings.

User intervention: No action is required. However, consider checking the cooling fans and the chassis ventilation for blockage.

High – The PECI Agent is running hot. This is a 'caution' level since the PECI Agent's 'Temperature Tolerance' has been reached (or has been exceeded) and may activate an overheat alarm. The system may shut down if it continues for a long period to prevent damage to the PECI Agent.

User intervention: If the system buzzer and Overheat LED has activated, take action immediately by checking the system fans, chassis ventilation and room temperature to correct any problems.

System Temperature

This item displays the absolute system temperature readings as detected by the BIOS:

Fan1-Fan8 Speeds

If the feature of Auto Fan Control is enabled, the BIOS will automatically display the status of the fans indicated in this item.

Fan Speed Control Modes

This feature allows the user to decide how the system controls the speeds of the onboard fans. The CPU temperature and the fan speed are correlative. When the CPU on-die temperature increases, the fan speed will also increase, and vice versa. If the option is set to 3-pin fan, the fan speed is controlled by voltage. If the option is set to 4-pin, the fan speed will be controlled by Pulse Width Modulation (PWM). Select 3-pin if your chassis came with 3-pin fan headers. Select 4-pin if your chassis came with 4-pin fan headers. Select Workstation if your system is used as a Workstation. Select Server if your system is used as a Server. Select Disable to disable fan speed control and allow the onboard fans to constantly run at full speed (12V). The Options are: 1. **Disable (running@Full Speed)**, 2. 3-pin (Server), 3. 3-pin (Workstation), 4. 4-pin (Server) and 5. 4-pin (Workstation).

Voltage Monitoring

The following items will be monitored and displayed:

Vcore A:/Vcore B:/-12V/+12V/5VDD/5Vsb/+3.3V/P1V2_NIC_SEN/P_VTT/Vbat

Note: In the Windows OS environment, the Supero Doctor III settings take precedence over the BIOS settings. When first installed, Supero Doctor III adopts the temperature threshold settings previously set in the BIOS. Any subsequent changes to these thresholds must be made within Supero Doctor, since the SD III settings override the BIOS settings. For the Windows OS to adopt the BIOS temperature threshold settings, please change the SDIII settings to be the same as those set in the BIOS.

► IPMI (The option is available only when an IPMI card is installed in the system.)

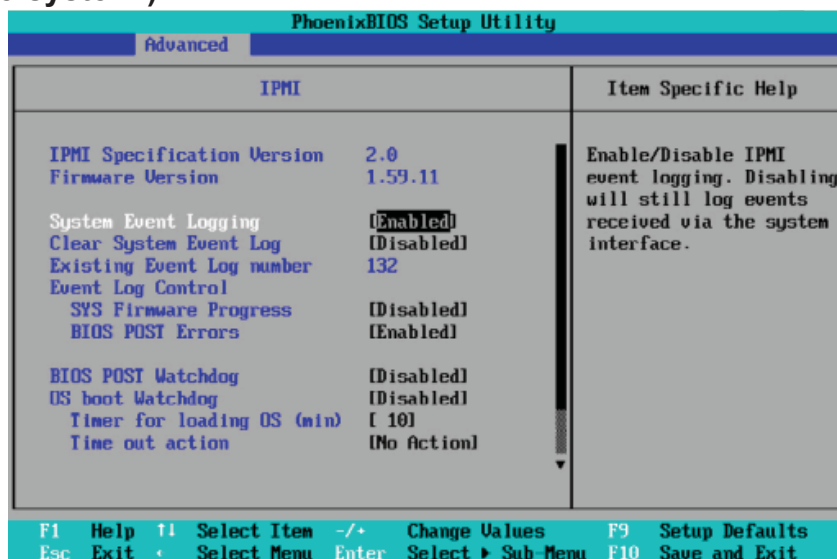

IPMI Specification Version: This item displays the current IPMI Version.

Firmware Version: This item displays the current Firmware Version.

System Event Logging

Select Enabled to enable IPMI Event Logging. When this function is set to Disabled, the system will continue to log events received via system interface. The options are **Enabled** and Disabled.

Clear System Event Logging

Enabling this function to force the BIOS to clear the system event logs during the next cold boot. The options are Enabled and **Disabled**.

Existing Event Log Number

This item displays the number of the existing event log.

Event Log Control

System Firmware Progress

Enabling this function to log POST progress. The options are Enabled and **Disabled**.

BIOS POST Errors

Enabling this function to log POST errors. The options are **Enabled** and Disabled.

BIOS POST Watch Dog

Set to Enabled to enable POST Watch Dog. The options are Enabled and **Disabled**.

OS Boot Watch Dog

Set to Enabled to enable OS Boot Watch Dog. The options are Enabled and Disabled.

Timer for Loading OS (Minutes)

This feature allows the user to set the time value (in minutes) for the previous item: OS Boot Watch Dog by keying-in a desired number in the blank. The default setting is 10 (minutes.) (Please ignore this option when OS Boot Watch Dog is set to Disabled.)

Time Out Option

This feature allows the user to determine what action to take in an event of a system boot failure. The options are **No Action**, Reset, Power Off and Power Cycles.

► System Event Log/System Event Log (List Mode)

These options display the System Event (SEL) Log and System Event (SEL) Log in List Mode. Items include: SEL (System Event Log) Entry Number, SEL Record ID, SEL Record Type, Time Stamp, Generator ID, SEL Message Revision, Sensor Type, Sensor Number, SEL Event Type, Event Description, and SEL Event Data.

PhoenixBIOS Setup Utility				
Advanced				
System Event Log (list mode)				
Event ID	Sensor Name	Sensor Type	Date/Time Stamp	
▶ 0001	Fan3	Fan	11.13.2008	17:39:09
	Lower Non-critical Going Low, Assertion			
▶ 0002	Fan3	Fan	11.13.2008	17:39:09
	Lower Critical Going Low, Assertion			
▶ 0003	Fan3	Fan	11.13.2008	17:39:09
	Lower Non-recoverable Going Low, Assertion			
▶ 0004	Intrusion	PhySec	11.17.2008	21:46:01
	General Chassis Intrusion			
▶ 0005	Intrusion	PhySec	11.17.2008	21:46:04
	General Chassis Intrusion			
▶ 0006	Intrusion	PhySec	00000058	
	General Chassis Intrusion			

F1	Help	↑	Select Item	-/+	Change Values	F9	Setup Defaults
Esc	Exit	←	Select Menu	Enter	Select ▶ Sub-Menu	F10	Save and Exit

► Realtime Sensor Data

This feature display information from motherboard sensors, such as temperatures, fan speeds and voltages of various components.

PhoenixBIOS Setup Utility					
Advanced					
Realtime Sensor Data					
Sensor Type	Sensor Name	Sensor Data	Sensor Units	Lower Limit	Upper Limit
Temp	Sys Temp	33.00	degrees C	0.00	75.00
Voltage	CPU1 Ucore	1.21	Volts	0.70	1.61
	CPU2 Ucore	0.00	Volts	0.70	1.61
	3.3V	3.31	Volts	2.96	3.63
	5V	4.92	Volts	4.48	5.49
	12V	11.00	Volts	10.75	13.24
	-12V	-12.00	Volts	-13.19	-10.00
	1.5V	1.50	Volts	1.34	1.64

F1 Help ↑ Select Item -/+ Change Values F9 Setup Defaults
Esc Exit ← Select Menu Enter Select ► Sub-Menu F10 Save and Exit

► IPMI LAN Configuration

The following features allow the user to configure and monitor IPMI LAN settings.

PhoenixBIOS Setup Utility	
Advanced	
IPMI Lan Configuration	Item Specific Help
ULAN Tagging	[Disabled]
ULAN ID	[1h]
IP Address Source	[DHCP]
IP Address	[192.168.001.020]
IP Subnet Mask	[255.255.255.000]
Default Gateway	[192.168.001.001]
MAC Address	[00h:30h:48h:99h:82h:F8h]
Update Lan Settings	[No]

F1 Help ↑ Select Item -/+ Change Values F9 Setup Defaults
Esc Exit ← Select Menu Enter Select ► Sub-Menu F10 Save and Exit

VLAN Tagging

Select Enabled to enable Virtual LAN(s) for IPMI connections and allow the user to configure VLAN settings. The options are Enabled and **Disabled**.

VLAN ID

If VLAN Tagging above is set to Enabled, this item allows the user to change the VLAN ID. If VLAN Tagging is disabled, this item will be ignored by the firmware.

IP Address Source

Select the source of this machine's IP address. If Static is selected, you will need to know and enter manually the IP address of this machine below. If DHCP is selected, the BIOS will search for a DHCP (Dynamic Host Configuration Protocol) server in the network it is attached to, and request the next available IP address. The options are **DHCP** and Static.

IP Address

This item displays the IP address for the IPMI connection detected.

IP Subnet Mask

This item displays the IP Subnet Mask for the IPMI connection detected.

Default Gateway

This item displays the Default Gateway for the IPMI connection detected.

MAC Address

This item displays the MAC Address for the IPMI connection detected.

Update LAN Settings

This item saves the IPMI Lan Configuration settings into memory. If you wish to change any of the settings, select Yes and press F10 to save your settings. Otherwise, leave this setting to its default setting of **No**.

4-5 Security Settings

Choose Security from the Phoenix BIOS Setup Utility main menu with the arrow keys. You should see the following display. Security setting options are displayed by highlighting the setting using the arrow keys and pressing <Enter>. All Security BIOS settings are described in this section.

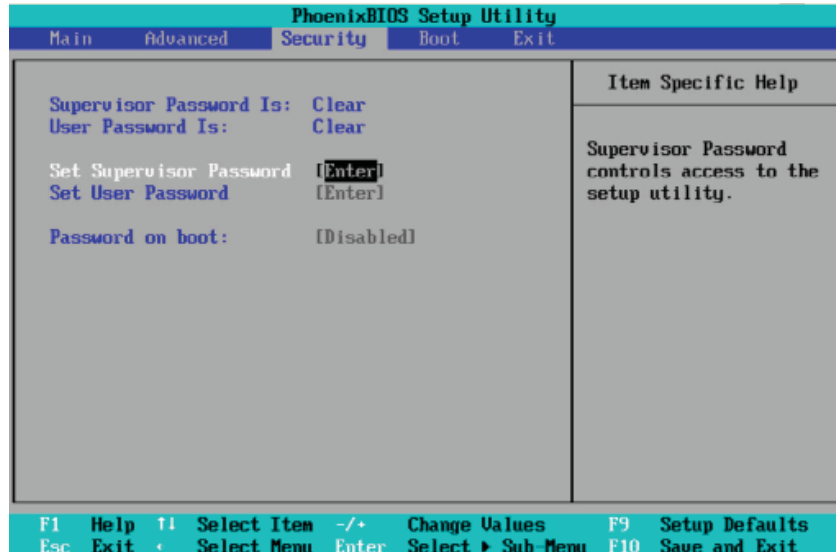

Supervisor Password Is:

This feature indicates if a supervisor password has been entered to the system. Clear means such a password has not been used, and Set means a supervisor password has been entered.

User Password Is:

This feature indicates if a user password has been entered to the system. Clear means such a password has not been used, and Set means a user password has been entered.

Set Supervisor Password

When this item is highlighted, hit the <Enter> key. When prompted, type the Supervisor's password in the dialogue box to set or to change supervisor's password to allow access to the BIOS.

Set User Password

When the item is highlighted, hit the <Enter> key. When prompted, type the user's password in the dialogue box to set or to change the user's password, which will allow access to the system at boot-up.

Password on Boot

This setting allows you to determine if a password is required for a user to enter the system at bootup. The options are Enabled (password required) and **Disabled** (password not required).

4-6 Boot Settings

Choose Boot from the Phoenix BIOS Setup Utility main menu with the arrow keys. You should see the following display. See details on how to change the order and specs of boot devices in the Item Specific Help window. All Boot BIOS settings are described in this section.

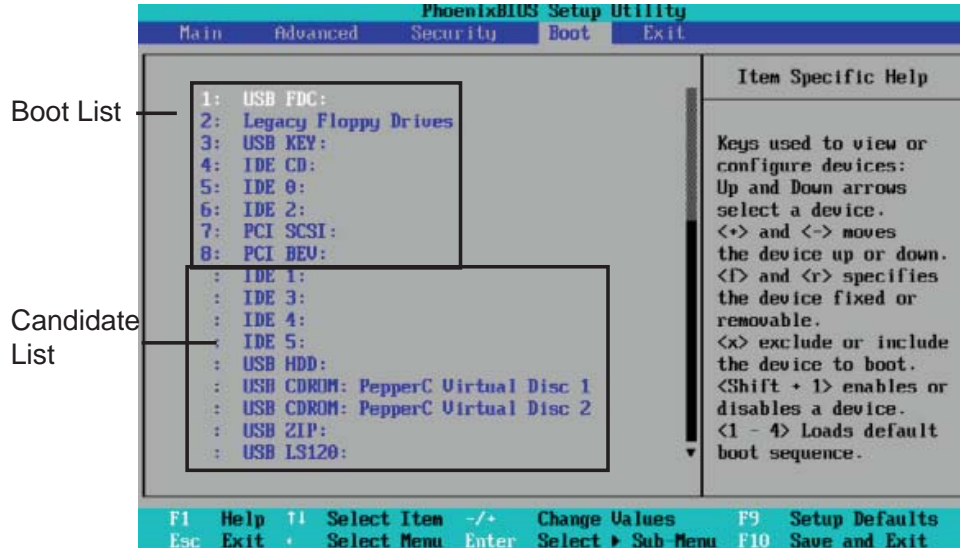

Boot Priority Order/Excluded from Boot Orders

The items included in the boot list section are bootable devices listed in the sequence of boot order as specified. The items included in the candidate list are currently not bootable. Use the <+> key or the <-> key to move the device up or down. Use the <f> key or the <r> key to specify the type of USB device, either fixed or removable. You can select one item from the boot list and hit the <x> key to remove it from the list of bootable devices (to make its resource available for other bootable devices). Conversely, you can select an item from the candidate list and hit the <x> key to remove it from the candidate list and put it in the boot list to make it bootable. See details on how to change the priority of boot order of devices in the "Item Specific Help" window.

4-7 Exit

Choose Exit from the Phoenix BIOS Setup Utility main menu with the arrow keys. You should see the following display. All Exit BIOS settings are described in this section.

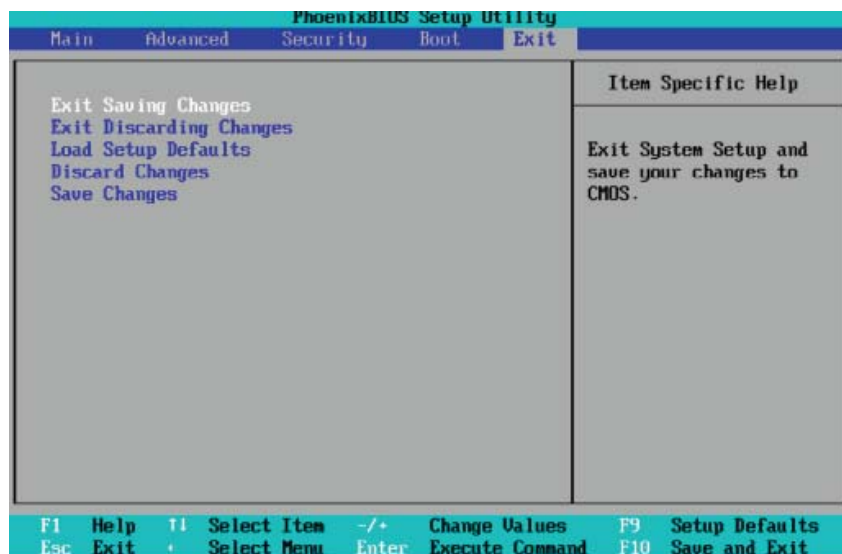

Exit Saving Changes

Highlight this item and hit <Enter> to save any changes you have made and to exit the BIOS Setup utility.

Exit Discarding Changes

Highlight this item and hit <Enter> to exit the BIOS Setup utility without saving any changes you may have made.

Load Setup Defaults

Highlight this item and hit <Enter> to load the default settings for all items in the BIOS Setup. These are the safest settings to use.

Discard Changes

Highlight this item and hit <Enter> to discard (cancel) any changes you have made. You will remain in the Setup utility.

Save Changes

Highlight this item and hit <Enter> to save any changes you have made. You will remain in the Setup utility.

Notes

Appendix A

BIOS Error Beep Codes

During the POST (Power-On Self-Test) routines, which are performed each time the system is powered on, errors may occur.

Non-fatal errors are those which, in most cases, allow the system to continue the boot-up process. The error messages normally appear on the screen.

Fatal errors are those which will not allow the system to continue the boot-up procedure. If a fatal error occurs, you should consult with your system manufacturer for possible repairs.

These fatal errors are usually communicated through a series of audible beeps. The numbers on the fatal error list, on the following page, correspond to the number of beeps for the corresponding error.

BIOS Error Beep Codes		
Beep Code	Error Message	Description
1 beep	Refresh	Circuits have been reset. (Ready to power up)
Repetition of the pattern of (1 long beep+ a short pause)	Memory error	No memory detected in the system
1 long beep + 2 short beeps	Display memory read/write error	Video adapter missing or with faulty memory
1 continuous beep (with the front panel OH LED on)	System Overheat	1 continuous beep with the front panel OH LED on)

Notes

Appendix B

Installing the Windows OS

After all hardware components have been installed, you must first configure Intel South Bridge RAID Settings before you install the Windows OS and other software drivers. To configure RAID settings, please refer to RAID Configuration User Guides posted on our website at www.supermicro.com/support/manuals.

B-1 Installing the Windows XP/2000/2003 OS for Systems with RAID Functions

1. Insert Microsoft's Windows XP/2000/2003 Setup CD in the CD Driver, and the system will start booting up from CD.
2. Press the <F6> key when the message-" Press F6 if you need to install a third party SCSI or RAID driver" displays.
3. When the Windows XP/2000/2003 Setup screen appears, press "S" to specify additional device(s).
4. Insert the driver diskette-"Intel AA RAID XP/2000/2003 Driver for ESB2" into Drive A: and press the <Enter> key.
5. Choose the Intel(R) ESB2 *SATA RAID Controller* from the list indicated in the XP/2000/2003 Setup Screen, and press the <Enter> key.
6. Press the <Enter> key to continue the installation process. (If you need to specify any additional devices to be installed, do it at this time.) Once all devices are specified, press the <Enter> key to continue with the installation.
7. From the Windows XP/2000/2003 Setup screen, press the <Enter> key. The XP/2000/2003 Setup will automatically load all device files and then, continue the Windows XP/2000/2003 installation.
8. After the Windows XP/2000/2003 OS Installation is completed, the system will automatically reboot.

B-2 Installing the Windows XP/2000/2003 OS for Systems without RAID Functions

1. Insert Microsoft's Windows XP/2000/2003 Setup CD in the CD Driver, and the system will start booting up from CD.
2. Continue with the OS installation. The Windows OS Setup screen will display.
3. From the Windows XP/2000/2003 Setup screen, press the <Enter> key. The XP/2000/2003 Setup will automatically load all device files and then continue with the Windows XP/2000/2003 installation.
4. After the Windows XP/2000/2003 OS Installation is completed, the system will automatically reboot.
5. Insert the Supermicro Setup CD that came with your motherboard into the CD Drive during system boot, and the main screen will display.

Appendix C

Installing Other Software Programs and Drivers

C-1 Installing Other Drivers

After you've installed the Windows Operating System, a screen as shown below will appear. You are ready to install software programs and drivers that have not yet been installed. To install these software programs and drivers, click the icons to the right of these items.

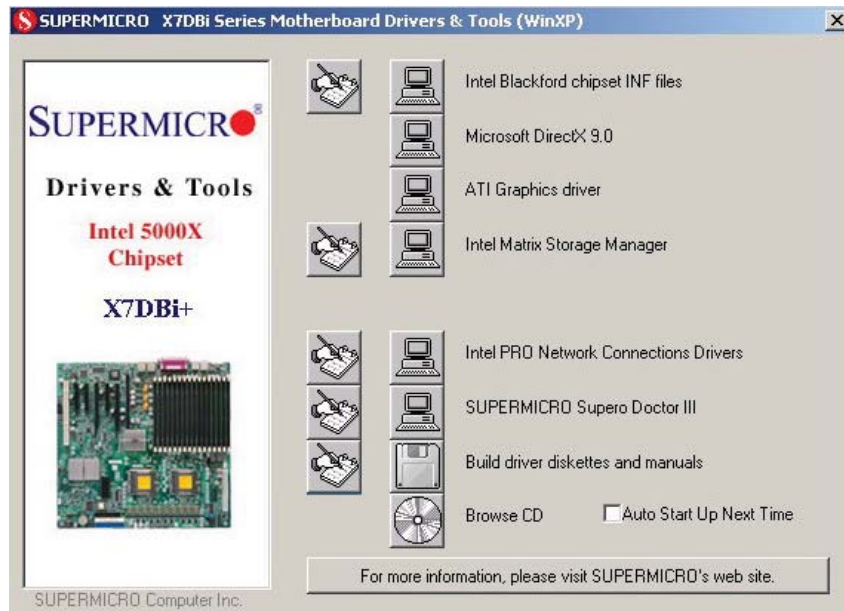

Driver/Tool Installation Display Screen

Notes:

1. Click the icons showing a hand writing on the paper to view the readme files for each item. Click on a computer icon to the right of an item to install an item (from top to the bottom) one at a time. After installing each item, you must reboot the system before proceeding with the next item on the list. The bottom icon with a CD on it allows you to view the entire contents of the CD.
2. When making a storage driver diskette by booting into a Driver CD, please set the SATA Configuration to "Compatible Mode" and configure SATA as IDE in the BIOS Setup. After making the driver diskette, be sure to change the SATA settings back to your original settings.

C-2 Configuring Supero Doctor III

The Supero Doctor III program is a Web-base management tool that supports remote management capability. It includes Remote and Local Management tools. The local management is called the SD III Client. The Supero Doctor III program included on the CDROM that came with your motherboard allows you to monitor the environment and operations of your system. Supero Doctor III displays crucial system information such as CPU temperature, system voltages and fan status. See the Figure below for a display of the Supero Doctor III interface.

Note: The default user name and password are ADMIN.

Note 2: In the Windows OS environment, the Supero Doctor III settings take precedence over the BIOS settings. When first installed, Supero Doctor III adopts the temperature threshold settings previously set in the BIOS. Any subsequent changes to these thresholds must be made within Supero Doctor, since the SD III settings override the BIOS settings. For the Windows OS to adopt the BIOS temperature threshold settings, please change the SDIII settings to be the same as those set in the BIOS.

Supero Doctor III Interface Display Screen-I (Health Information)



Supero Doctor III Interface Display Screen-II (Remote Control)



Note: SD III Software Revision 1.0 can be downloaded from our Web site at: ftp://ftp.supermicro.com/utility/Supero_Doctor_III/. You can also download SDIII User's Guide at: <http://www.supermicro.com/PRODUCT/Manuals/SDIII/UserGuide.pdf>. For Linux, we will still recommend that you use Supero Doctor II.

Notes

(Disclaimer continued)

The products sold by Supermicro are not intended for and will not be used in life support systems, medical equipment, nuclear facilities or systems, aircraft, aircraft devices, aircraft/emergency communication devices or other critical systems whose failure to perform be reasonably expected to result in significant injury or loss of life or catastrophic property damage. Accordingly, Supermicro disclaims any and all liability, and should buyer use or sell such products for use in such ultra-hazardous applications, it does so entirely at its own risk. Furthermore, buyer agrees to fully indemnify, defend and hold Supermicro harmless for and against any and all claims, demands, actions, litigation, and proceedings of any kind arising out of or related to such ultra-hazardous use or sale.